

T O K

PRODUCT CATALOG

BEARINGS

BEARINGS

— ベアリング —



樹脂ベアリングのパイオニア 多彩な形状・材質で様々なニーズにお応えします。

Plastic bearings with variegated configuration and materials reply to customer's demand. (PAT.P)

樹脂ベアリング・樹脂ローラー (Dシリーズ)

標準タイプ	DR-H	3
内輪ネジ軸タイプ	DR-B	4-5
内輪カシメ軸タイプ	DR-A	6
六角ネジ穴タイプ	DR・DO・DU・DV・DH・ER-B	7
ステンレス仕様	DR-S	8
外輪Rタイプ	DO-H,A,B	9
外輪U溝タイプ	DU-H,A,B	10
外輪V溝タイプ	DV-H,A,B	11
外輪凹溝タイプ	DH-H,A,B	12
外輪フランジ付き	DF-H,B	12
カシメ軸付きローラー	DL-A	13
ネジ軸付きローラー	DL-B	13

帯電防止ベアリング (Eシリーズ)

内輪ネジ軸タイプ	ER-B	13
----------	------	----

高荷重 (金属インサート) ベアリング (I・DTシリーズ)

樹脂 (PA) タイヤ	IN-A,B	※保持器仕様	14
樹脂 (POM) タイヤ	ID-H,A	※保持器仕様	14
樹脂 (POM) タイヤ	IDS-H,A,B	※総ボール仕様	15
樹脂 (POM) タイヤ	DT	※JISベアリング	16

耐薬品ベアリング (PE・PK・PVシリーズ)

超高分子量ポリエチレン	PE	17
PEEK	PK	18
PVDF	PV	18
ステンレス	S・SS	19
セラミックス	C	20

ウレタン巻きベアリング (UTシリーズ)

ポリウレタン	UT	21
--------	----	----

銅製ベアリング (A・AS・TAS・THFシリーズ)

鋼 (標準)	A・AS	22
鋼 (強靱性)	TAS	23
プレス	THF	24

戸車

25-26

特注ベアリング (Kシリーズ)

設計情報	K	27
------	---	----

BEARING 品名構成表

BEARING NUMBER COMPOSITION

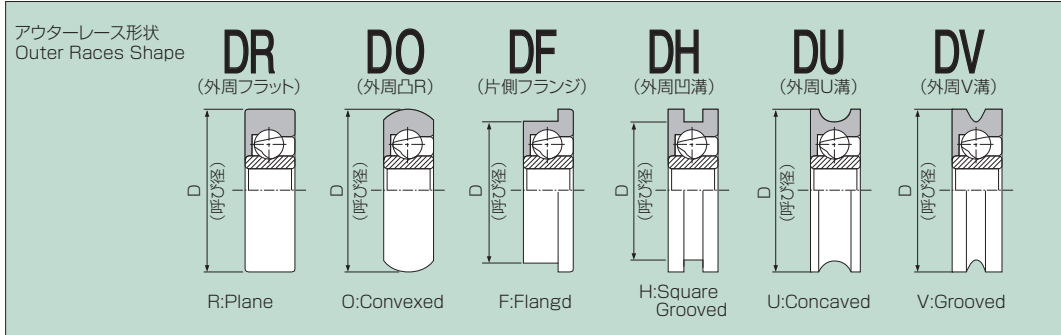

アウターレース外径寸法 Index number of outer races diameter

アウターレース形状記号のDHタイプ凹溝は、溝底径で表わし、DFタイプの片側フランジは段下径の寸法で表わします。 Generally, the number means overall diameter of bearings except for the DH-type with square-groove bearings of which index number indicate each bottom-to-bottom diameter, and the DF-type with flanged shape bearings of which index number indicate each diameter of tread of the races.

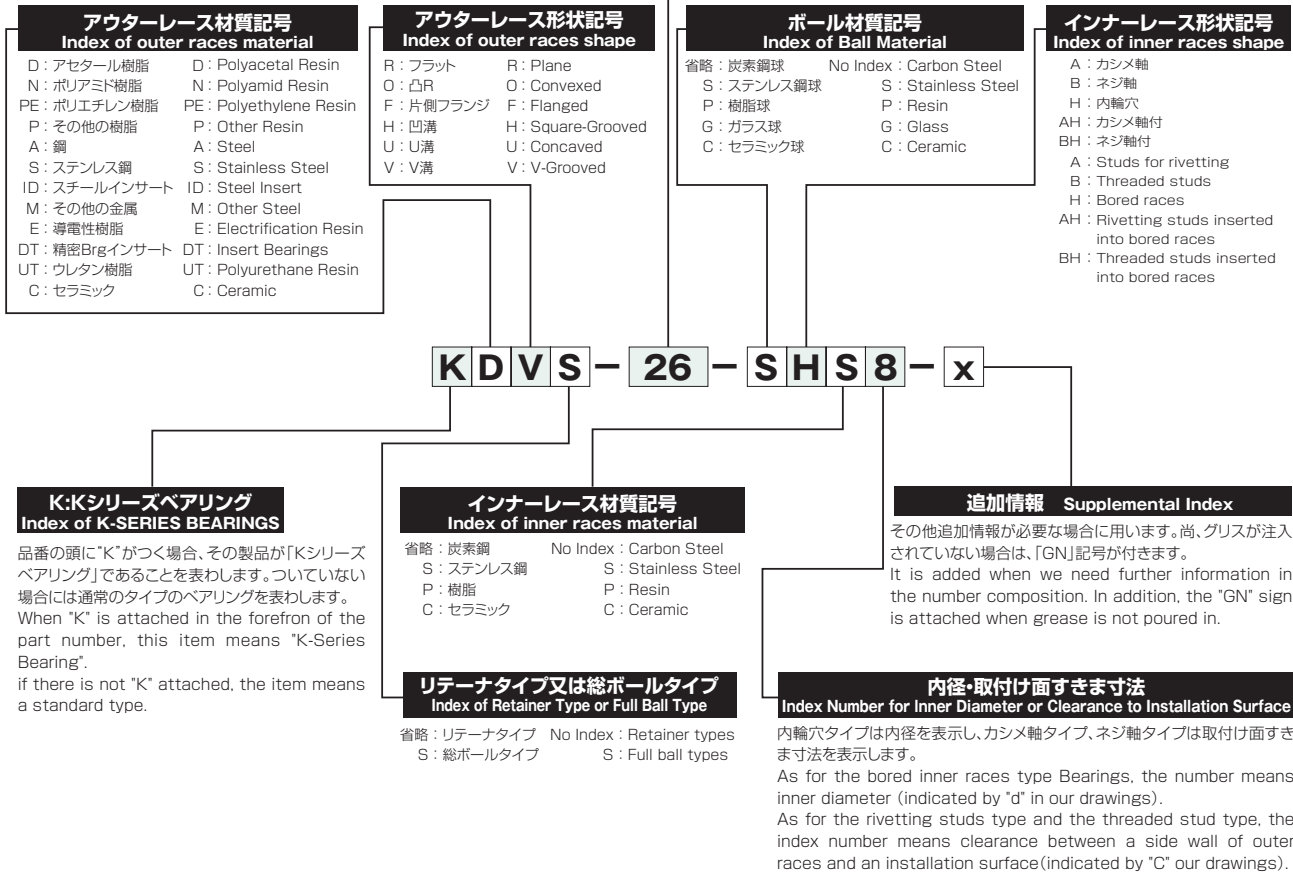

【ベアリング注意事項】

1. 使用温度範囲: 0°C ~ 40°C (用途に応じて -20°C ~ 60°C まで低温設計可能です)
2. カタログ中の許容荷重は総回転数 100 万回での数値です。(弊社耐久試験機による)
3. アキシャル方向に荷重が加わらないようご使用ください。

【Bearings】

1. Operation temperature : 0°C ~ 40°C (Special designing for use - 20°C ~ 60°C is also available)
2. Load capacity indicated in the brochure is based on 1,000,000 revolution test with TOK BEARING durability testing machine.
3. Do not use bearings under axial load.

DR-H (標準タイプ) RoHS

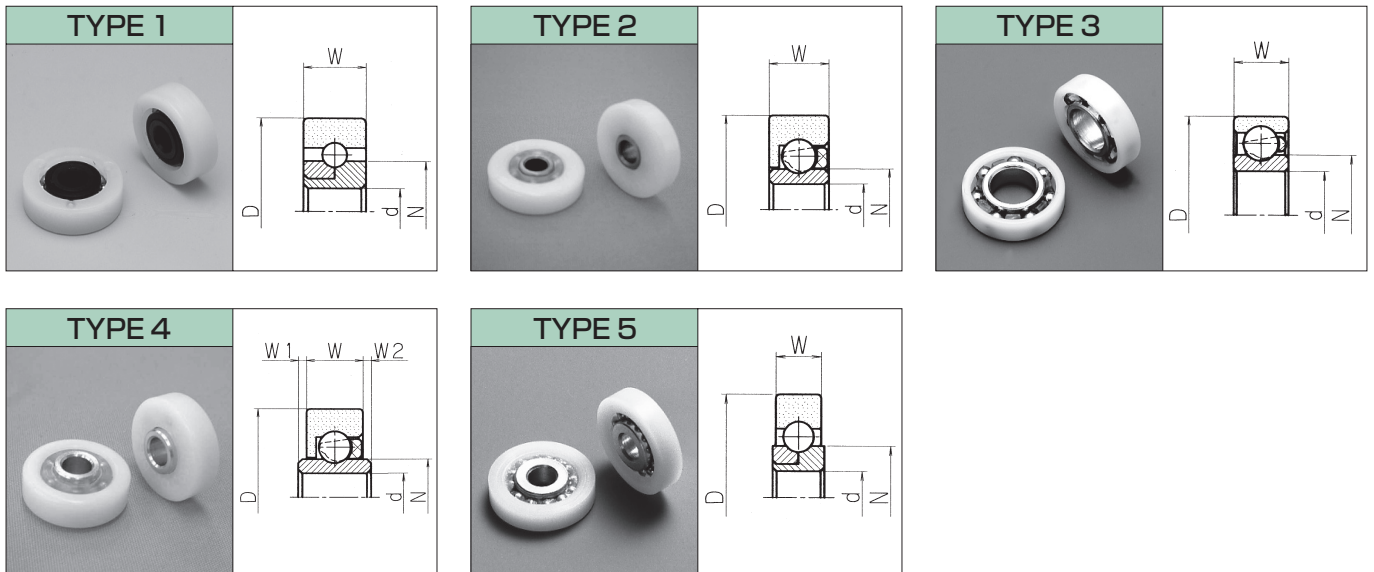

Code	Part No.	D _{-0.1} [mm]	d ₀ ^{+0.1} [mm]	W _{-0.2} [mm]	W1*1 [mm]	W2*1 [mm]	N [mm]	Load*2 [N] (kgf)	Type	Q'ty [pcs/box]	Gross Weight [kg/box]
040012	DRS-9-H2.5	9 _{-0.05}	2.5 ₀ ^{+0.05}	3 ^{±0.1}	—	—	(5.4)	9.8 (1)	1	10,000	—
040013	DRS-12-H3	12 _{-0.05}	3 ₀ ^{+0.05}	4 ^{±0.1}	—	—	(6.5)	9.8 (1)	1	10,000	—
040100	DR-18-H6	18	6	6	—	—	(8.2)	49 (5)	2	2,500	7.6
040202	DR-19-H5	19	5	6	—	—	(8.2)	49 (5)	2	2,500	8.9
040205	DR-19-H6	19	6	6	—	—	(8.2)	49 (5)	2	2,500	8.1
040301	DR-20-H8	20	8	6 ^{±0.1}	—	—	(11.0)	29.4 (3)	2	1,500	6.1
040401	DR-22-H6	22	6	7	—	—	(9.5)	196 (20)	2	1,500	9.5
040412	DR-22-H8	22	8	7	—	—	(11.0)	49 (5)	2	1,500	8.2
040600	DR-24-H6	24	6	7	—	—	(9.5)	196 (20)	2	1,000	7.1
040602	DR-24-H10.5	24	10.5	7	—	—	(13.0)	49 (5)	2	1,000	11.5
040701	DR-26-H6	26	6	7	—	—	(9.5)	196 (20)	2	1,000	7.8
041600	DR-26-H10	26	10	8	—	—	(13.0)	196 (20)	2	1,000	7.9
040800	DR-28-H6	28	6	7	—	—	(9.5)	196 (20)	2	500	4.2
041000	DR-30-H6	30	6	7	—	—	(9.5)	196 (20)	2	500	5.6
041610	DR-30-H10-9	30	10	9	—	—	(14.5)	245 (25)	2	500	7.7
041005	DR-30-H10-8	30	10	8 ^{±0.1}	—	—	(14.5)	245 (25)	2	500	6.7
041612	DR-32-H12	32	12	10	—	—	(17.0)	294 (30)	2	500	9.6
041100	DR-35-H6	35	6	7	—	—	(9.5)	196 (20)	2	500	5.7
041614	DR-35-H15	35	15	11 ^{±0.2}	—	—	(21.0)	294 (30)	2	400	10.6
041151	DR-38-H10	38	10	8 ^{±0.2}	—	—	(13.0)	196 (20)	2	500	6.1
041200	DR-40-H6	40 _{-0.2}	6	8	—	—	(9.5)	196 (20)	2	400	5.4
041616	DR-40-H17	40	17	12 ^{±0.2}	—	—	(21.0)	294 (30)	2	250	6.9
041618	DR-47-H20	47	20	14	—	—	(27.0)	343 (35)	2	150	8.7
040102	DR-18-H8	18	8	5	—	—	(11.0)	49 (5)	3	3,000	8.7
040007	DR-16-H4.1W0.25	16	4.1	4	0.25	0.25	(8.5)	19.6 (2)	4	4,000	9.6
040200	DR-19-H4W (1.3) 3	19	4	6	1.3	3	(8.2)	49 (5)	4	1,500	8.2
040204	DR-19-H5W (0) 2.3	19	5	6	0	2.3	(8.2)	49 (5)	4	2,000	8.6
040400	DR-22-H4W (0.5) 3	22	4	7	0.5	3	(9.5)	196 (20)	4	1,000	8.3
040415	DR-22-H6W1	22	6	7	1	1	(9.5)	196 (20)	4	1,000	6.6
040601	DR-24-H6W1	24	6	7	1	1	(9.5)	196 (20)	4	1,000	7.3
040700	DR-26-H4W (0.5) 3	26	4	7	0.5	3	(9.5)	196 (20)	4	1,000	9.7
040704	DR-26-H6W1	26	6	7	1	1	(9.5)	196 (20)	4	1,000	8.8
040802	DR-28-H6W1	28	6	7	1	1	(9.5)	196 (20)	4	500	4.5
041003	DR-30-H6W1	30	6	7	1	1	(9.5)	196 (20)	4	500	6.4
041101	DR-35-H6W1	35	6	7	1	1	(9.5)	196 (20)	4	500	6.8
041201	DR-40-H6W0.5	40 _{-0.2}	6	8	0.5	0.5	(9.5)	196 (20)	4	400	5.5
041300	DR-47-H8W (0) 9	47	8	14	0	9	(27.0)	196 (20)	4	100	3.5
040005	DRS-16-H4.1W0.25	16	4.1	3.5 ^{±0.2}	0.25	0.25	(8.0)	49 (5)	5	5,000	11.0

*1 参考値 Reference Dimension *2 許容荷重 (毎分300回 回転時) Allowable Load at 300min⁻¹ (300r.p.m)
 *3 上記以外のサイズ・形状につきましては、弊社までご相談ください。Each limiting size can be changed for practical application. Please ask our engineer for further information.

DR-B (ネジ軸タイプ) RoHS

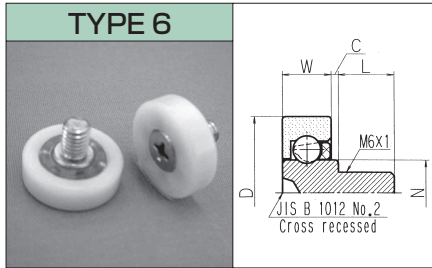

Code	Part No.	D _{-0.1} [mm]	W _{-0.2} [mm]	C ^{±0.4} [mm]	L ^{±0.5} [mm]	N [mm]	Load ^{*1} [N] (kgf)	Type	Q'ty [pcs/box]	Gross Weight [kg/box]
020200	DR-19-B0.5	19	6	0.5	8	(8.2)	49 (5)	6	2,000	12.5
020207	DR-19-B1-14	19	6	1	14	(8.2)	49 (5)	6	1,500	11.1
020208	DR-19-B1.5	19	6	1.5	8	(8.2)	49 (5)	6	2,000	12.9
020212	DR-19-B3.5	19	6	3.5	8	(8.2)	49 (5)	6	1,500	11.0
020404	DR-22-B0.5-4.5	22	7	0.5	4.5	(9.5)	196 (20)	6	1,000	8.4
020400	DR-22-B0.5	22	7	0.5	8	(9.5)	196 (20)	6	1,000	9.8
020408	DR-22-B1-10	22	7	1	10	(9.5)	196 (20)	6	1,000	9.5
020428	DR-22-B3-10.5	22	7	3	10.5	(9.5)	196 (20)	6	1,000	11.5
020427	DR-22-B3.6-12.4	22	7	3.6	12.4	(9.5)	196 (20)	6	1,000	10.9
020415	DR-22-B3.6-14.5	22	7	3.6	14.5	(9.5)	196 (20)	6	1,000	11.9
020600	DR-24-B0.5	24	7	0.5	8	(9.5)	196 (20)	6	1,000	10.4
020608	DR-24-B3-10.5	24	7	3	10.5	(9.5)	196 (20)	6	1,000	11.7
020702	DR-26-B0.5-4.5	26	7	0.5	4.5	(9.5)	196 (20)	6	1,000	9.7
020700	DR-26-B0.5	26	7	0.5	8	(9.5)	196 (20)	6	1,000	10.1
020720	DR-26-B3-10.5	26	7	3	10.5	(9.5)	196 (20)	6	800	10.7
020719	DR-26-B3.6-12.4	26	7	3.6	12.4	(9.5)	196 (20)	6	800	11.3
020714	DR-26-B5-11	26	7	5	11	(9.5)	196 (20)	6	800	8.8
020800	DR-28-B0.5	28	7	0.5	8	(9.5)	196 (20)	6	500	6.7
020803	DR-28-B2-15	28	7	2	15	(9.5)	196 (20)	6	500	6.7
020805	DR-28-B3-10.5	28	7	3	10.5	(9.5)	196 (20)	6	500	6.9
021000	DR-30-B0.5	30	7	0.5	8	(9.5)	196 (20)	6	500	6.8
021005	DR-30-B3-10.5	30	7	3	10.5	(9.5)	196 (20)	6	500	7.6
021004	DR-30-B3.6-12.4	30	7	3.6	12.4	(9.5)	196 (20)	6	500	12.5

*1 許容荷重 (毎分300回 回転時) Allowable Load at 300min⁻¹ (300r.p.m)

*2 上記以外のサイズ・形状につきましては、弊社までご相談ください。

Each limiting size can be changed for practical application. Please ask our engineer for further information.

DR-B (ネジ軸タイプ) RoHS

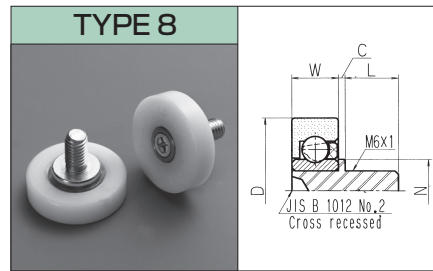
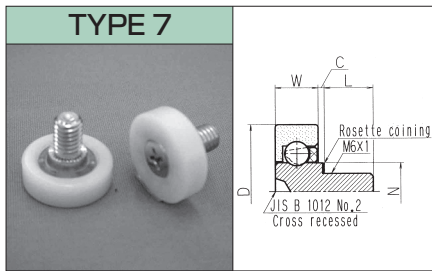

Code	Part No.	D _{-0.1} [mm]	W _{-0.2} [mm]	C ^{±0.4} [mm]	L ^{±0.5} [mm]	N [mm]	Load ^{*1} [N] (kgf)	Type	Q'ty [pcs/box]	Gross Weight [kg/box]
020205	DR-19-B1-5.5	19	6	1	5.5	(8.2)	49 (5)	7	2,000	11.5
020204	DR-19-B1	19	6	1	8	(8.2)	49 (5)	7	2,000	13.5
020210	DR-19-B2-4.5	19	6	2	4.5	(8.2)	49 (5)	7	2,000	12.1
020209	DR-19-B2	19	6	2	8	(8.2)	49 (5)	7	2,000	14.0
020211	DR-19-B2.7	19	6	2.7	8	(8.2)	49 (5)	7	1,500	10.2
020214	DR-19-B3	19	6	3	8	(8.2)	49 (5)	7	1,500	10.7
020406	DR-22-B1	22	7	1	8	(9.5)	196 (20)	7	1,000	9.0
020411	DR-22-B2-5.5	22	7	2	5.5	(9.5)	196 (20)	7	1,000	9.3
020409	DR-22-B2	22	7	2	8	(9.5)	196 (20)	7	1,000	10.3
020413	DR-22-B3	22	7	3	8	(9.5)	196 (20)	7	1,000	11.3
020418	DR-22-B4-4.5	22	7	4	4.5	(9.5)	196 (20)	7	1,000	10.3
020416	DR-22-B4	22	7	4	8	(9.5)	196 (20)	7	1,000	11.7
020420	DR-22-B5	22	7	5	8	(9.5)	196 (20)	7	1,000	12.3
020422	DR-22-B6	22	7	6	8	(9.5)	196 (20)	7	1,000	12.8
020602	DR-24-B2	24	7	2	8	(9.5)	196 (20)	7	1,000	11.4
020604	DR-24-B3	24	7	3	8	(9.5)	196 (20)	7	1,000	11.7
020605	DR-24-B4	24	7	4	8	(9.5)	196 (20)	7	1,000	12.4
020606	DR-24-B5	24	7	5	8	(9.5)	196 (20)	7	1,000	12.5
020607	DR-24-B6	24	7	6	8	(9.5)	196 (20)	7	1,000	13.3
020705	DR-26-B2	26	7	2	8	(9.5)	196 (20)	7	800	9.2
020707	DR-26-B3	26	7	3	8	(9.5)	196 (20)	7	800	9.7
020710	DR-26-B4	26	7	4	8	(9.5)	196 (20)	7	800	10.1
020716	DR-26-B6-6	26	7	6	6	(9.5)	196 (20)	7	800	10.7
020715	DR-26-B6	26	7	6	8	(9.5)	196 (20)	7	800	11.1
020801	DR-28-B2	28	7	2	8	(9.5)	196 (20)	7	500	6.7
021002	DR-30-B3	30	7	3	8	(9.5)	196 (20)	7	500	11.3
020429	DR-22-BH2-11	22	7	2	11	(13.0)	196 (20)	8	1,000	12.3
020430	DR-22-BH3-11	22	7	3	11	(11.0)	196 (20)	8	1,000	11.4
020722	DR-26-BH2-11	26	7	2	11	(13.0)	196 (20)	8	800	10.6
020804	DR-28-BH2-11	28	7	2	11	(13.0)	196 (20)	8	500	6.9

*1 許容荷重 (毎分 300 回 回転時) Allowable Load at 300min⁻¹ (300r.p.m)

*2 上記以外のサイズ・形状につきましては、弊社までご相談ください。

Each limiting size can be changed for practical application. Please ask our engineer for further information.

DR-A (カシメ軸タイプ) RoHS

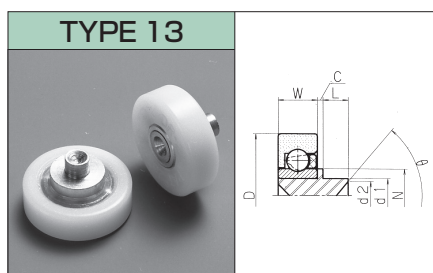
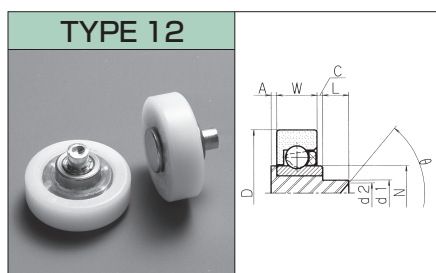
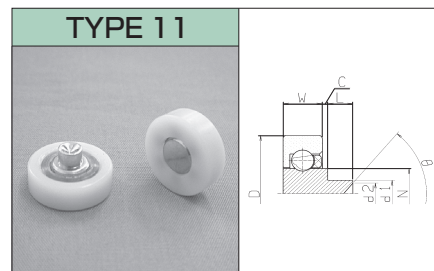
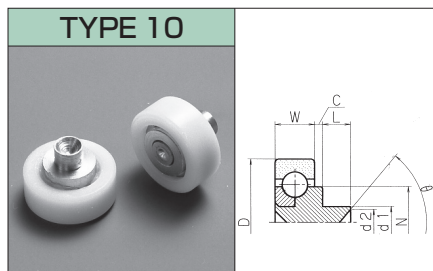
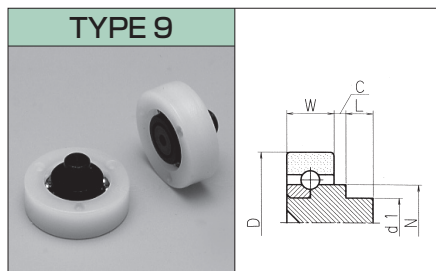

Code	Part No.	D _{-0.1} [mm]	d1 _{-0.1} [mm]	W _{0-0.2} [mm]	C ^{±0.4} [mm]	L ^{±0.2} [mm]	(d2 × θ) ^{*1}	A ^{±0.2} [mm]	N [mm]	Load ^{*2} [N] (kgf)	Type	Q'ty [pcs/box]	Gross Weight [kg/box]
000006	DRS-9-A0.5	9 _{-0.05}	2 _{-0.05}	3 _{-0.1}	0.5	1.8	—	—	(4.0)	[9.8] (1)	9	10,000	—
000007	DRS-12-A0.5	12 _{-0.05}	3 _{-0.05}	4 ^{±0.1}	0.5 ^{±0.3}	2.3	—	—	(6.5)	[9.8] (1)	9	10,000	—
000001	DRS-16-A1	16 _{-0.3}	4	5 ^{±0.2}	1	3.5	φ3 ×100°	—	(9.0)	19.6 (2)	10	2,000	9.0
000003	DRS-16-A1.5	16 _{-0.3}	5	6.35 ^{±0.2}	1.5	3.5	φ4.5 × 90°	—	(9.0)	19.6 (2)	10	2,500	14.4
000100	DR-18-A0.5	18	5	6	0.5	3.5	φ4 ×120°	—	(8.2)	19.6 (2)	11	2,000	9.6
000200	DR-19-A0.5	19	5	6	0.5	3.5	φ4 ×120°	—	(8.2)	29.4 (3)	11	2,000	10.7
000207	DR-19-A2	19	5	6	2	3.5	φ4.4 ×120°	—	(8.2)	29.4 (3)	11	2,000	11.6
000400	DR-22-A1	22	5	7	1	3.5	φ4.4 × 90°	—	(9.5)	78.4 (8)	11	1,000	9.0
000410	DR-22-A2-φ6	22	6	7	2	3.5	φ5.5 × 90°	—	(9.5)	78.4 (8)	11	1,000	9.4
000411	DR-22-A2	22	5	7	2	3.5	φ4 × 90°	—	(9.5)	78.4 (8)	11	1,000	8.9
000600	DR-24-A1	24	5	7	1	3.5	φ4.4 × 90°	—	(9.5)	78.4 (8)	11	1,000	9.5
000700	DR-26-A1	26	5	7	1	3.5	φ4.4 × 90°	—	(9.5)	78.4 (8)	11	1,000	10.2
000800	DR-28-A1	28	5	7	1	3.5	φ4.4 × 90°	—	(9.5)	78.4 (8)	11	500	5.8
000900	DR-29-A1	29	5	7	1	3.5	φ4.4 × 90°	—	(9.5)	78.4 (8)	11	500	5.7
000427	DR-22-AH(1)3.5-8019	22	4.5 ^{±0.1}	7	0	3.5 ^{+0.3} ₀	nothing	1	(9.5)	196 (20)	12	1,000	9.1
000419	DR-22-AH2.5-3.65	22	4.5 ^{±0.1}	7	2.5	3.65	φ2.5 ×100°	1	(9.5)	196 (20)	12	1,000	10.2
000705	DR-26-AH	26	4.5 ^{±0.1}	7	0	3.5 ^{+0.3} ₀	nothing	1 ^{±0.3}	(9.5)	196 (20)	12	1,000	10.2
000707	DR-26-AH2.5-3.65	26	4.5 ^{±0.1}	7	2.5	3.65	φ2.5 ×100°	1	(9.5)	196 (20)	12	800	8.8
040707	DR-26-AH2.7-2.7	26	3.9 _{-0.2}	7	2.7	2.7	φ2.3 ×110°	1 ^{±0.3}	(9.5)	196 (20)	12	800	8.8
040706	DR-26-AH2.7-4	26	3.9 _{-0.2}	7	2.7	4 ^{±0.3}	φ2.7 ×120°	1 ^{±0.3}	(9.5)	196 (20)	12	800	9.8
000414	DR-22-AH2.5	22	5	7	2.5	3.5	φ4 ×110°	—	(11.0)	196 (20)	13	1,000	10.0
000416	DR-22-AH3.8-2.5	22	4.9	7	3.8	2.5	nothing	—	(11.0)	196 (20)	13	1,000	10.6
000417	DR-22-AH4	22	5	7	4	3.5	φ4 ×110°	—	(11.0)	196 (20)	13	1,000	10.8
000706	DR-26-AH4	26	5	7	4	3.5	φ4 ×110°	—	(11.0)	196 (20)	13	800	9.8

*1 参考値 Reference Dimension

*2 許容荷重 (毎分300回 回転時) Allowable Load at 300min⁻¹ (300r.p.m)

*3 上記以外のサイズ・形状につきましては、弊社までご相談ください。Each limiting size can be changed for practical application. Please ask our engineer for further information.

六角ネジ穴タイプベアリング

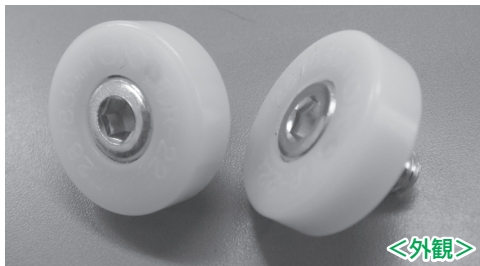

＜特長＞ **RoHS**

- 高い締め付け力で、ゆるみの防止による信頼性の向上
- 狭いスペースの適用と作業性の向上

TYPE DR

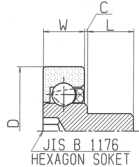

TYPE	CODE	Part No.	D _{-0.1} [mm]	W _{-0.2} [mm]	C ^{±0.4} [mm]	L ^{±0.5} [mm]	使用六角レンチ
DR	020561	DR-22-BO.5-JH	22	7	0.5	M6×8	呼び4
DR	020611	DR-24-BO.5-JH	24	7	0.5	M6×8	呼び4
DR	020744	DR-26-BO.5-JH	26	7	0.5	M6×8	呼び4
DR	020808	DR-28-BO.5-JH	28	7	0.5	M6×8	呼び4
DR	021013	DR-30-BO.5-JH	30	7	0.5	M6×8	呼び4
DR	021103	DR-35-BO.5-JH	35	7	0.5	M6×8	呼び4

TYPE DO

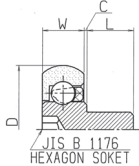

TYPE	CODE	Part No.	D _{-0.1} [mm]	W _{-0.2} [mm]	C ^{±0.4} [mm]	L ^{±0.5} [mm]	使用六角レンチ
DO	071066	DO-22-BO.5-JH	22	7	0.5	M6×8	呼び4
DO	071037	DO-24-BO.5-JH	24	7	0.5	M6×8	呼び4
DO	071069	DO-26-BO.5-JH	26	7	0.5	M6×8	呼び4
DO	071054	DO-28-BO.5-JH	28	7	0.5	M6×8	呼び4
DO	071070	DO-30-BO.5-JH	30	7	0.5	M6×8	呼び4
DO	071071	DO-35-BO.5-JH	35	7	0.5	M6×8	呼び4

TYPE DU

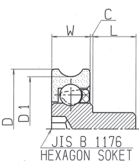

TYPE	CODE	Part No.	D ^{±0.2} [mm]	D1 ^{±0.1} [mm]	W _{-0.2} [mm]	C ^{±0.4} [mm]	L ^{±0.5} [mm]	使用六角レンチ
DU	081086	DU-22-BO.5-JH	22	19.2	7	0.5	M6×8	呼び4
DU	081036	DU-24-BO.5-JH	24	21.2	7	0.5	M6×8	呼び4
DU	081044	DU-26-BO.5-JH	26	23.2	7	0.5	M6×8	呼び4
DU	081052	DU-28-BO.5-JH	28	24	7	0.5	M6×8	呼び4
DU	081065	DU-30-BO.5-JH	30	25.7	7	0.5	M6×8	呼び4
DU	081066	DU-35-BO.5-JH	35	31	7	0.5	M6×8	呼び4

TYPE DV

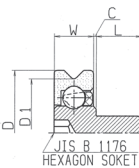

TYPE	CODE	Part No.	D ^{±0.2} [mm]	D1 ^{±0.2} [mm]	W _{-0.2} [mm]	C ^{±0.4} [mm]	L ^{±0.5} [mm]	使用六角レンチ
DV	091104	DV-22-BO.5-JH	22	19	7	0.5	M6×8	呼び4
DV	091203	DV-24-BO.5-JH	24	21	7	0.5	M6×8	呼び4
DV	091305	DV-26-BO.5-JH	26	23	7	0.5	M6×8	呼び4
DV	091400	DV-28-BO.5-JH	28	24	7	0.5	M6×8	呼び4
DV	091505	DV-30-BO.5-0.5R-JH	30	28	7	0.5	M6×8	呼び4
DV	091506	DV-30-BO.5-JH	30	27	7	0.5	M6×8	呼び4

TYPE DH

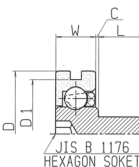

TYPE	CODE	Part No.	D ^{±0.2} [mm]	D1 ^{±0.2} [mm]	W _{-0.2} [mm]	C ^{±0.4} [mm]	L ^{±0.5} [mm]	使用六角レンチ
DH	101022	DH-19-BO.5-2-JH	22	19	7	0.5	M6×8	呼び4
DH	101041	DH-21-BO.5-2-JH	24	21	7	0.5	M6×8	呼び4

TYPE ER

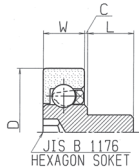

TYPE	CODE	Part No.	D[mm]	W[mm]	C ^{±0.4} [mm]	L ^{±0.5} [mm]	使用六角レンチ
ER	720115	ER-22-BO.5-JH	22 ^{±0.2}	7 _{-0.2}	0.5	M6×8	呼び4
ER	720116	ER-24-BO.5-JH	24 _{-0.1}	7 _{-0.2}	0.5	M6×8	呼び4
ER	720117	ER-26-BO.5-JH	26 _{-0.1}	7 _{-0.3}	0.5	M6×8	呼び4
ER	720118	ER-28-BO.5-JH	28 _{-0.1}	7 _{-0.2}	0.5	M6×8	呼び4
ER	720119	ER-30-BO.5-JH	30 _{-0.1}	7 _{-0.4}	0.5	M6×8	呼び4
ER	720120	ER-35-BO.5-JH	35 _{-0.1}	7 _{-0.4}	0.5	M6×8	呼び4

* 別途ご確認をお願いします。

DR-S (ステンレス仕様) RoHS

アウターレースはポリアセタール樹脂を使用し、インナーレース、ボールにステンレスを使用したベアリングです。

The outer race are made of polyacetal resin, and the inner race and balls are made of stainless steel.

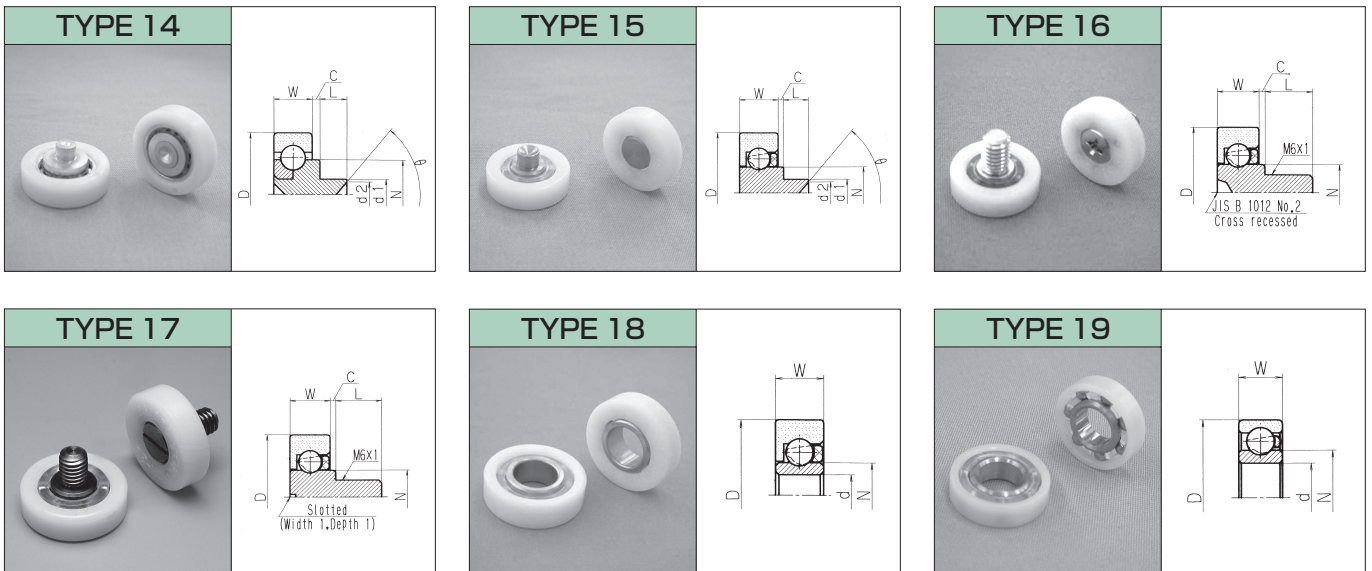

Code	Part No.	D _{-0.1} [mm]	d ^{+0.1} [mm]	d1 _{-0.1} [mm]	W _{-0.2} [mm]	C ^{±0.4} [mm]	L ^{±0.2} [mm]	(d2×θ) ^{*1}	N [mm]	Load ^{*2} [N] (kgf)	Type	Q'ty [pcs/box]	Gross Weight [kg/box]
000002	DRS-16-SAS1-GN	16 _{-0.3}	—	4	5 ^{±0.2}	1	3.5	φ3×100°	(9.0)	—	14	2,000	9.0
000202	DR-19-SAS0.5-GN	19	—	5	6	0.5	3.5 _{-0.2}	φ4×120°	(8.2)	—	15	2,000	10.7
000421	DR-22-SAS1	22	—	5	7	1 ^{±0.3}	3.4 ^{±0.1}	φ4×90°	(9.5)	—	15	1,000	9.0
020202	DR-19-SBS0.5	19	—	—	6	0.5	8 ^{±0.5}	—	(8.2)	—	16	2,000	12.5
020442	DR-22-SBS0.5-GN	22	—	—	7	0.5	8 ^{±0.5}	—	(9.5)	—	17	1,000	9.8
020443	DR-22-SBS2	22	—	—	7	2	8 ^{±0.5}	—	(9.5)	—	17	1,000	10.3
020735	DR-26-SBS0.5	26	—	—	7	0.5 ^{±0.3}	8 ^{±0.5}	—	(9.5)	—	17	1,000	10.1
021001	DR-30-SBS0.5	30	—	—	7	0.5	8 ^{±0.5}	—	(9.5)	—	17	500	6.8
021100	DR-35-SBS0.5	35	—	—	7	0.5 ^{±0.3}	8 ^{±0.5}	—	(9.5)	—	17	300	4.0
040101	DR-18-SHS6-GN	18	6	—	6	—	—	—	(8.2)	—	18	2,500	7.8
040207	DR-19-SHS6	19	6	—	6	—	—	—	(8.2)	—	18	2,500	8.1
040404	DR-22-SHS6-GN	22	6	—	7	—	—	—	(9.5)	—	18	1,000	7.0
040414	DR-22-SHS8-GN	22	8	—	7	—	—	—	(11.0)	—	18	1,000	5.3
040801	DR-28-SHS6-GN	28	6	—	7	—	—	—	(9.5)	—	18	500	4.2
041601	DR-26-SHS10-GN	26	10	—	8	—	—	—	(13.0)	98 (10)	18	1,000	7.9
041611	DR-30-SHS10-GN	30	10	—	9	—	—	—	(14.5)	147 (15)	18	500	7.7
041613	DR-32-SHS12-GN	32	12	—	10	—	—	—	(17.0)	176 (18)	18	500	9.6
041615	DR-35-SHS15-GN	35	15	—	11	—	—	—	(21.0)	176 (18)	18	400	10.6
041617	DR-40-SHS17-GN	40	17	—	12	—	—	—	(21.0)	205 (21)	18	250	6.9
041619	DR-47-SHS20-GN	47	20	—	14	—	—	—	(27.0)	235 (24)	18	150	8.7
040103	DR-18-SHS8	18	8	—	5	—	—	—	(11.0)	—	19	3,000	8.7

*1 参考値 Reference Dimension

*2 許容荷重 (毎分300回 回転時) Allowable Load at 300min⁻¹ (300r.p.m)

*3 上記以外のサイズ・形状につきましては、弊社までご相談ください。

Each limiting size can be changed for practical application. Please ask our engineer for further information.

※上記は受注生産品です。 These products manufactured to order.

DO (外軸Rタイプ) RoHS

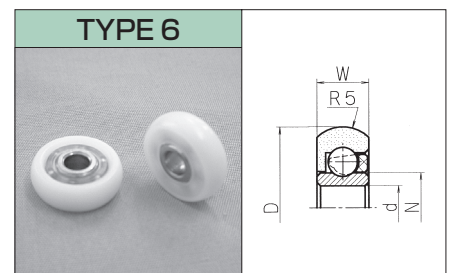
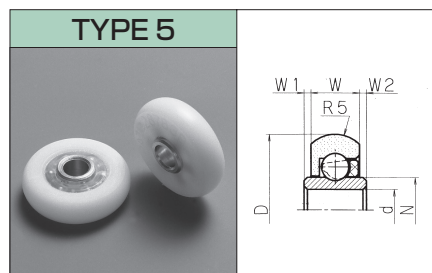
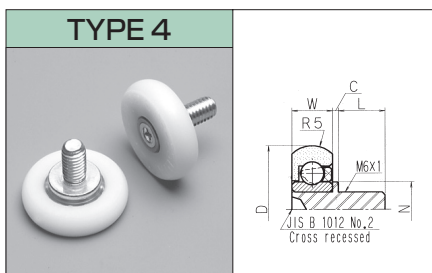
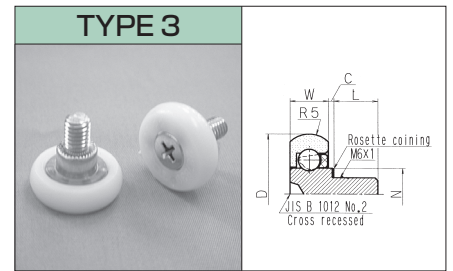
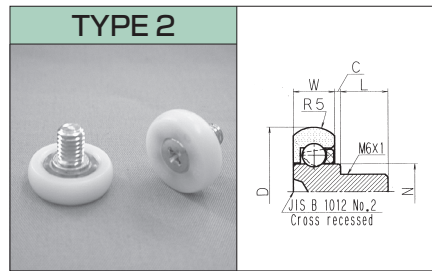
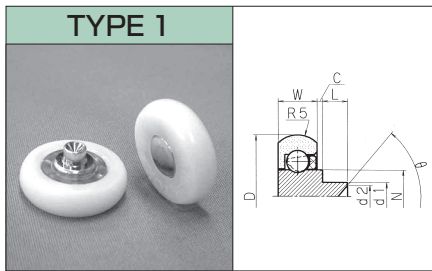

Code	Part No.	D _{-0.2} [mm]	d ^{+0.1} [mm]	d1 _{-0.1} [mm]	W _{-0.2} [mm]	C ^{±0.4} [mm]	L ^{±0.2} [mm]	(d2 × θ) ^{*1}	W1 ^{*1} [mm]	W2 ^{*1} [mm]	N [mm]	Load ^{*2} [N] (kgf)	Type	Q'ty [pcs/box]	Gross Weight [kg/box]
070010	DO-19-A0.5	19	—	5	6	0.5	3.5	φ4 × 120°	—	—	(8.2)	29.4 (3)	1	2,000	10.8
070020	DO-22-A1	22	—	5	7	1	3.5	φ4.4 × 90°	—	—	(9.5)	78.4 (8)	1	1,000	8.9
070021	DO-22-A3	22	—	5	7	3	3.5	φ4 × 90°	—	—	(9.5)	78.4 (8)	1	1,000	9.3
070030	DO-24-A1	24	—	5	7	1	3.5	φ4.4 × 90°	—	—	(9.5)	78.4 (8)	1	1,000	9.8
070040	DO-26-A1	26	—	5	7	1	3.5	φ4.4 × 90°	—	—	(9.5)	78.4 (8)	1	1,000	10.3
071010	DO-19-B0.5	19	—	—	6	0.5	8 ^{±0.5}	—	—	—	(8.2)	49 (5)	2	2,000	12.5
071012	DO-19-B0.5-4.5	19	—	—	6	0.5	4.5 ^{±0.5}	—	—	—	(8.2)	49 (5)	2	2,000	10.3
071020	DO-22-B0.5	22	—	—	7	0.5	8 ^{±0.5}	—	—	—	(9.5)	196 (20)	2	1,000	9.3
071026	DO-22-B3-10.5	22	—	—	7	3	10.5 ^{±0.5}	—	—	—	(9.5)	196 (20)	2	1,000	10.4
071030	DO-24-B0.5	24	—	—	7	0.5	8 ^{±0.5}	—	—	—	(9.5)	196 (20)	2	1,000	10.3
071040	DO-26-B0.5	26	—	—	7	0.5	8 ^{±0.5}	—	—	—	(9.5)	196 (20)	2	1,000	10.7
071050	DO-28-B0.5	28	—	—	7	0.5	8 ^{±0.5}	—	—	—	(9.5)	196 (20)	2	500	6.3
071023	DO-22-B5	22	—	—	7	5	8 ^{±0.5}	—	—	—	(9.5)	196 (20)	3	1,000	11.2
071031	DO-24-B2	24	—	—	7	2	8 ^{±0.5}	—	—	—	(9.5)	196 (20)	3	1,000	10.8
071032	DO-24-B3	24	—	—	7	3	8 ^{±0.5}	—	—	—	(9.5)	196 (20)	3	1,000	11.8
071034	DO-24-B4	24	—	—	7	4	8 ^{±0.5}	—	—	—	(9.5)	196 (20)	3	1,000	11.6
071060	DO-30-B3	30	—	—	7	3	8 ^{±0.5}	—	—	—	(9.5)	196 (20)	3	500	6.4
071035	DO-24-BH0.5	24	—	—	7	0.5	8 ^{±0.5}	—	—	—	(9.5)	196 (20)	4	1,000	8.8
071045	DO-26-BH2-11	26	—	—	7	2	11 ^{±0.5}	—	—	—	(13.0)	196 (20)	4	800	10.1
072031	DO-24-H6W1	24	6	—	7	—	—	—	1	1	(9.5)	196 (20)	5	1,000	7.8
072043	DO-26-H6W1	26	6	—	7	—	—	—	1	1	(9.5)	196 (20)	5	1,000	8.5
072072	DO-35-H6W1	35	6	—	7	—	—	—	1	1	(9.5)	196 (20)	5	500	5.1
072080	DO-40-H6W0.5	40	6	—	8 _{-0.3}	—	—	—	0.5	0.5	(9.5)	196 (20)	5	400	4.5
072000	DO-18-H5	18	5	—	6	—	—	—	—	—	(8.2)	49 (5)	6	2,500	8.1
072010	DO-19-H5	19	5	—	6	—	—	—	—	—	(8.2)	49 (5)	6	2,500	9.8
072020	DO-22-H6	22	6	—	7	—	—	—	—	—	(9.5)	196 (20)	6	1,500	8.9
072030	DO-24-H6	24	6	—	7	—	—	—	—	—	(9.5)	196 (20)	6	1,000	7.3
072040	DO-26-H6	26	6	—	7	—	—	—	—	—	(9.5)	196 (20)	6	1,000	8.0
072050	DO-28-H6	28	6	—	7	—	—	—	—	—	(9.5)	196 (20)	6	800	8.7
072060	DO-29-H6	29	6	—	7 _{-0.1}	—	—	—	—	—	(9.5)	196 (20)	6	500	4.0

*1 参考値 Reference Dimension

*2 許容荷重 (毎分300回 回転時) Allowable Load at 300min⁻¹ (300r.p.m)

*3 上記以外のサイズ・形状につきましては、弊社までご相談ください。Each limiting size can be changed for practical application. Please ask our engineer for further information.

DU (外輪U溝タイプ) RoHS

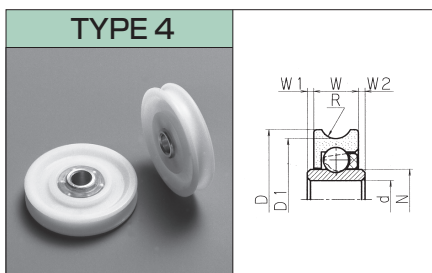
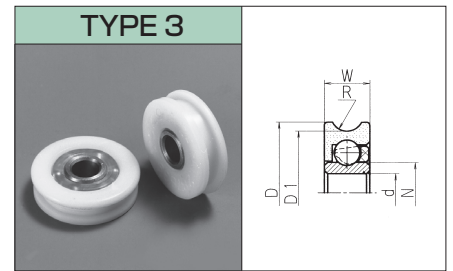
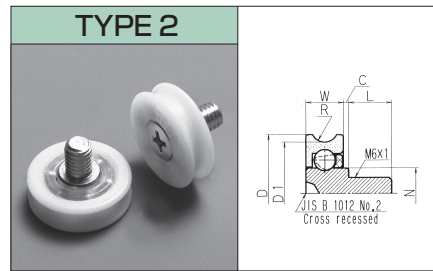
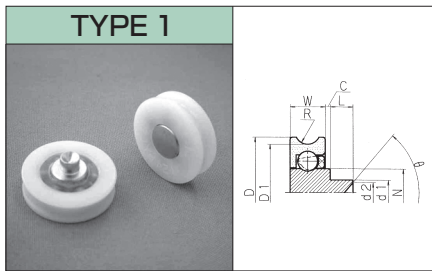

Code	Part No.	D ^{±0.2} [mm]	D1 ^{±0.1} [mm]	d ^{+0.1} ₀ [mm]	d1 ⁻⁰ _{-0.1} [mm]	W ⁻⁰ _{-0.2} [mm]	C ^{±0.4} [mm]	L ^{±0.2} [mm]	*1 (d2×θ)	W1 ^{*1} [mm]	W2 ^{*1} [mm]	R	N [mm]	Load ^{*2} [N] (kgf)	Type	Q'ty [pcs/box]	Gross Weight [kg/box]
080010	DU-19-A0.5	19	17	—	5	6	0.5	3.5	φ4 ×120°	—	—	1.75	(8.2)	29.4 (3)	1	2,000	10.3
080020	DU-22-A1	22	19.2	—	5	7	1	3.5	φ4.4× 90°	—	—	2.5	(9.5)	58.8 (6)	1	1,000	8.5
080030	DU-24-A1	24	21.2	—	5	7	1	3.5	φ4.4× 90°	—	—	2.5	(9.5)	58.8 (6)	1	1,000	9.3
080040	DU-26-A1	26	23.2	—	5	7	1	3.5	φ4.4× 90°	—	—	2.5	(9.5)	58.8 (6)	1	1,000	10.3
081010	DU-19-B0.5	19	17	—	—	6	0.5	8 ^{±0.5}	—	—	—	1.75	(8.2)	39.2 (4)	2	2,000	12.4
081013	DU-19-B2	19	17	—	—	6	2	8 ^{±0.5}	—	—	—	1.75	(8.2)	39.2 (4)	2	2,000	12.8
081020	DU-22-B0.5	22	19.2	—	—	7	0.5	8 ^{±0.5}	—	—	—	2.5	(9.5)	156 (16)	2	1,000	9.8
081021	DU-22-B6	22	19.2	—	—	7	6	8 ^{±0.5}	—	—	—	2.5	(9.5)	156 (16)	2	1,000	11.8
081030	DU-24-B0.5	24	21.2	—	—	7	0.5	8 ^{±0.5}	—	—	—	2.5	(9.5)	156 (16)	2	1,000	10.5
081040	DU-26-B0.5	26	23.2	—	—	7	0.5	8 ^{±0.5}	—	—	—	2.5	(9.5)	156 (16)	2	1,000	11.3
082010	DU-19-H5	19	17	5	—	6	—	—	—	—	—	1.75	(8.2)	39.2 (4)	3	2,500	9.8
082020	DU-22-H6	22	19.2	6	—	7	—	—	—	—	—	2.5	(9.5)	156 (16)	3	1,500	8.8
082060	DU-24-H6	24	21.2	6	—	7	—	—	—	—	—	2.5	(9.5)	156 (16)	3	1,000	6.7
082070	DU-26-H6	26	23.2	6	—	7	—	—	—	—	—	2.5	(9.5)	156 (16)	3	1,000	7.4
082100	DU-30-H6-M	30	25.7	6	—	7 ^{±0.2}	—	—	—	—	—	2.5	(9.5)	156 (16)	3	500	3.6
082101	DU-30-H10	30	26	10	—	8 ^{±0.2}	—	—	—	—	—	2.5	(14.5)	196 (20)	3	500	6.1
082031	DU-22-H6W0.5	22	19	6	—	7	—	—	—	0.5	0.5	2.5	(9.5)	156 (16)	4	1,500	5.8
082028	DU-22-H6W1	22	19.2	6	—	7	—	—	—	1	1	2.5	(9.5)	156 (16)	4	1,000	6.2
082090	DU-28-H6W1	28	24	6	—	7	—	—	—	1	1	2.5	(9.5)	156 (16)	4	800	8.0
082103	DU-30-H6W1	30	25.7	6	—	7	—	—	—	1	1	2.5	(9.5)	156 (16)	4	500	6.1
082110	DU-35-H6W1	35	31	6	—	7	—	—	—	1	1	2.5	(9.5)	156 (16)	4	500	5.8
082120	DU-40-H6W0.5	40	36	6	—	8 ^{±0.2}	—	—	—	0.5	0.5	2.5	(9.5)	156 (16)	4	400	5.4

*1 参考値 Reference Dimension

*2 許容荷重 (毎分300回 回転時) Allowable Load at 300min⁻¹ (300r.p.m)

*3 上記以外のサイズ・形状につきましては、弊社までご相談ください。Each limiting size can be changed for practical application. Please ask our engineer for further information.

DV (外軸V溝タイプ) RoHS

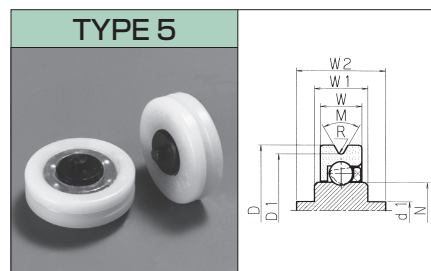
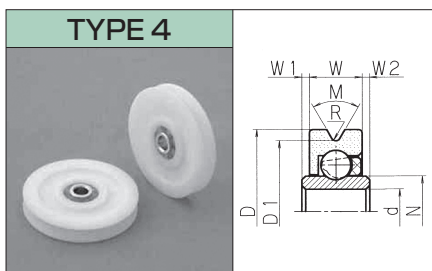
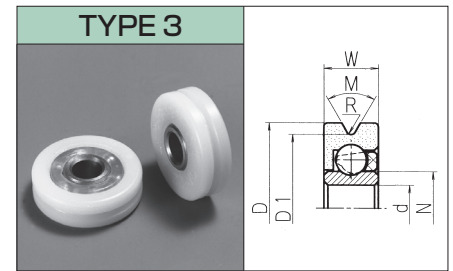
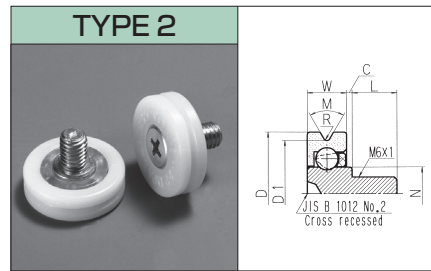
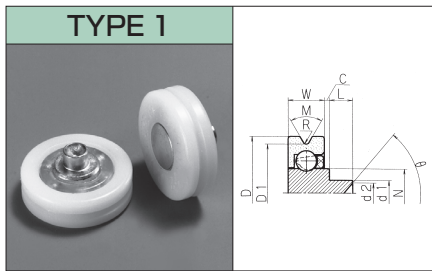

Code	Part No.	D ^{±0.2} [mm]	D1 ^{±0.2} [mm]	d ^{+0.1} ₀ [mm]	d1 ⁰ _{-0.1} [mm]	W ⁰ _{-0.2} [mm]	C ^{±0.4} [mm]	L ^{±0.2} [mm]	*1 (d2 × θ)	W1 ^{*1} [mm]	W2 ^{*1} [mm]	M°	R	N [mm]	Type	Q'ty [pcs/box]	Gross Weight [kg/box]
090000	DV-19-A0.5	19	17	—	5	6	0.5	3.5	φ4 × 120°	—	—	60	0.6	(8.2)	1	2,000	11.0
090100	DV-22-A1	22	19	—	5	7	1	3.5	φ4.4 × 90°	—	—	60	0.6	(9.5)	1	1,000	9.2
090200	DV-24-A1	24	21	—	5	7	1	3.5	φ4.4 × 90°	—	—	60	0.6	(9.5)	1	1,000	9.8
090300	DV-26-A1	26	23	—	5	7	1	3.5	φ4.4 × 90°	—	—	60	0.6	(9.5)	1	1,000	10.6
090400	DV-28-A1	28	24	—	5	7	1	3.5	φ4.4 × 90°	—	—	60	0.6	(9.5)	1	500	5.3
090500	DV-30-A1	30	27	—	5	7	1	3.5	φ4.4 × 90°	—	—	60	0.6	(9.5)	1	500	6.5
090600	DV-38-A0.5	38	35	—	5	8 ^{±0.2}	0.5	3.5	φ4.4 × 90°	—	—	60	0.6	(9.5)	1	500	7.5
091000	DV-19-B0.5	19	17	—	—	6	0.5	8 ^{±0.5}	—	—	—	60	0.6	(8.2)	2	2,000	12.6
091100	DV-22-B0.5	22	19	—	—	7	0.5	8 ^{±0.5}	—	—	—	60	0.6	(9.5)	2	1,000	10.0
091200	DV-24-B0.5	24	21	—	—	7	0.5	8 ^{±0.5}	—	—	—	60	0.6	(9.5)	2	1,000	10.6
091201	DV-24-B3	24	21	—	—	7	3	8 ^{±0.5}	—	—	—	60	0.6	(9.5)	2	1,000	10.7
091300	DV-26-B0.5	26	23	—	—	7	0.5	8 ^{±0.5}	—	—	—	60	0.6	(9.5)	2	1,000	11.2
091500	DV-30-B0.5-0.5R	30	28	—	—	7	0.5	8 ^{±0.5}	—	—	—	90	0.5	(9.5)	2	500	8.0
091501	DV-32.5-B1.5-2R	32.5	20.5	—	—	9.5 ^{±0.2}	1.5	8 ^{±0.5}	—	—	—	15	2	(9.5)	2	400	6.6
091600	DV-38-B0.5	38	35	—	—	8 ^{±0.2}	0.5	8 ^{±0.5}	—	—	—	60	0.6	(9.5)	2	250	5.8
092001	DV-19-H5	19	17	5	—	6	—	—	—	—	—	60	0.6	(8.2)	3	2,500	10.0
092100	DV-22-H6-M	22	19	6	—	7	—	—	—	—	—	60	0.6	(9.5)	3	1,500	9.7
092200	DV-24-H6	24	21	6	—	7	—	—	—	—	—	60	0.6	(9.5)	3	1,000	7.4
092201	DV-24-H8	24	20 ^{±1}	8	—	7	—	—	—	—	—	30	0.6	(11.0)	3	1,000	5.6
092300	DV-26-H6	26	23	6	—	7	—	—	—	—	—	60	0.6	(9.5)	3	1,000	8.0
092500	DV-30-H6	30	27	6	—	7	—	—	—	—	—	60	0.6	(9.5)	3	500	6.8
092700	DV-48-H6W0.4-1.6R	48.3	35	6	—	8.2 ^{±0.2}	—	—	—	0.4	0.4	30	1.6	(9.5)	4	250	4.1
090102	DV-22-AW0.5-B	22 ^{-0.1}	19 ^{±0.1}	—	3	7	—	—	—	8	12	60	0.65	(9.5)	5	1,000	8.9

*1 参考値 Reference Dimension

*2 上記以外のサイズ・形状につきましては、弊社までご相談ください。Each limiting size can be changed for practical application. Please ask our engineer for further information.

※ 上記は受注生産品です。These products manufactured to order.

DH (外輪凹溝タイプ) RoHS

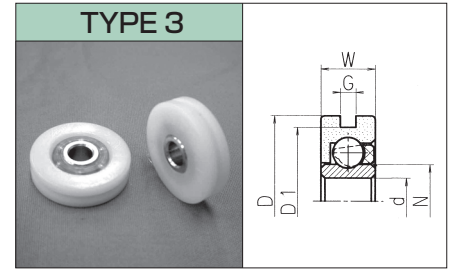
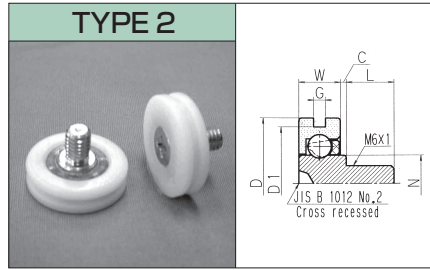
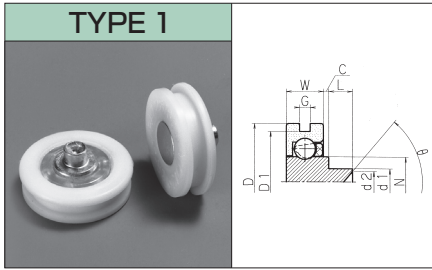

Code	Part No.	D ^{±0.2} [mm]	D1 ^{±0.2} [mm]	d ^{+0.1} [mm]	d1 ^{-0.1} [mm]	W ^{-0.2} [mm]	C ^{±0.4} [mm]	L ^{±0.2} [mm]	(d2×θ) ^{*1}	G ^{±0.2} [mm]	N [mm]	Type	Q'ty [pcs/box]	Gross Weight [kg/box]
100000	DH-16-A0.5	19	16	—	5	6	0.5	3.5	φ4×120°	2.1	(8.2)	1	2,000	10.9
101012	DH-16-B0.5	19	16	—	—	6	0.5	8 ^{±0.5}	—	2.1	(8.2)	2	2,000	12.5
101013	DH-16-B1	19	16	—	—	6	1	8 ^{±0.5}	—	2.1	(8.2)	2	2,000	11.8
101020	DH-19-B0.5-2	22	19	—	—	7	0.5	8 ^{±0.5}	—	2	(9.5)	2	1,000	9.9
101040	DH-21-B0.5-2	24	21	—	—	7	0.5	8 ^{±0.5}	—	2	(9.5)	2	1,000	10.5
102010	DH-16-H5	19	16	5	—	6	—	—	—	2.1	(8.2)	3	2,000	9.9
102021	DH-19-H6-2	22	19	6	—	7	—	—	—	2	(9.5)	3	1,000	9.6
102025	DH-19-H6-2.5	22	19	6	—	7	—	—	—	2.5	(9.5)	3	1,500	8.4
102040	DH-21-H6-2	24	21	6	—	7	—	—	—	2	(9.5)	3	1,000	7.3
102041	DH-21-H6-3	24	21	6	—	7	—	—	—	3	(9.5)	3	1,000	6.5
102042	DH-21-H6-3.2	24	21	6	—	7	—	—	—	3.2	(9.5)	3	1,000	6.2

*1 参考値 Reference Dimension

*2 上記以外のサイズ・形状につきましては、弊社までご相談ください。Each limiting size can be changed for practical application. Please ask our engineer for further information.

※上記は受注生産品です。These products manufactured to order.

DF (外輪フランジタイプ) RoHS

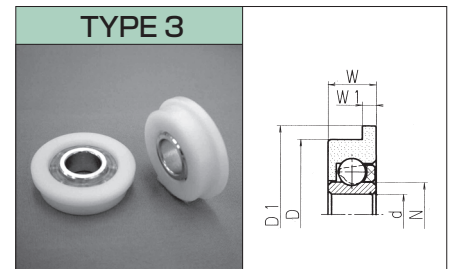
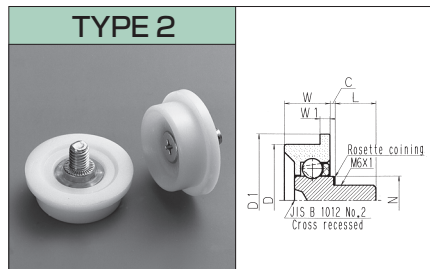
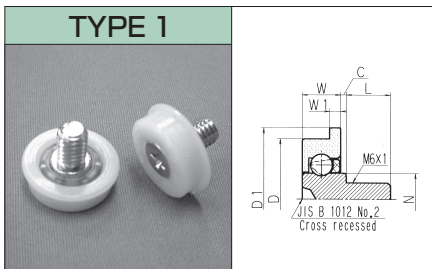

Code	Part No.	D ^{-0.1} [mm]	D1 ^{±0.2} [mm]	d ^{+0.1} [mm]	W ^{-0.2} [mm]	W1 ^{±0.2} [mm]	C ^{±0.4} [mm]	L ^{±0.5} [mm]	N [mm]	Load ^{*1} [N] (kgf)	Load ^{*2} [N] (kgf)	Type	Q'ty [pcs/box]	Gross Weight [kg/box]
061001	DF-17-B0.5	17	19	—	6	1	0.5	8	(8.2)	49 (5)	—	1	1,500	10.0
061020	DF-22-B0.5	22	26	—	7	2	0.5	8	(9.5)	196 (20)	—	1	1,000	9.4
061040	DF-26-B1	26 ^{±0.2}	32	—	11 ^{±0.2}	3	1	8	(9.5)	196 (20)	—	2	400	5.3
061043	DF-26-B2	26 ^{±0.2}	32	—	11 ^{±0.2}	3	2	8	(9.5)	196 (20)	—	2	400	5.8
062000	DF-17-H6	17	19 ^{±0.1}	6	6	1 ^{±0.1}	—	—	(8.2)	49 (5)	14.7 (1.5)	3	3,000	9.5
062005	DF-19-H6	19	22	6	7	1.5	—	—	(9.5)	147 (15)	29.4 (3)	3	1,500	7.7
062020	DF-22-H6	22	26	6	7	2	—	—	(9.5)	196 (20)	39.2 (4)	3	1,500	9.5
062027	DF-23-H10	23	24.75	10	8 ^{±0.2}	1.5 ^{±0.1}	—	—	(13.0)	98 (10)	39.2 (4)	3	1,000	7.2
062061	DF-30-H10-3	30	34	10	8.5 ^{±0.2}	3	—	—	(14.5)	245 (25)	58.8 (6)	3	500	7.0
062062	DF-32-H12	32	36	12	10	3	—	—	(17.0)	245 (25)	58.8 (6)	3	400	7.5

*1 アウターレース回転許容荷重 (毎分 300 回 回転時) Allowable Load at 300min⁻¹ (300r.p.m) rotation of outer-race

*2 インナーレース回転許容荷重 (毎分 300 回 回転時) Allowable Load at 300min⁻¹ (300r.p.m) rotation of inner-race

*3 上記以外のサイズ・形状につきましては、弊社までご相談ください。Each limiting size can be changed for practical application. Please ask our engineer for further information.

DL (カシメ軸付きローラー, ネジ軸付きローラー) RoHS

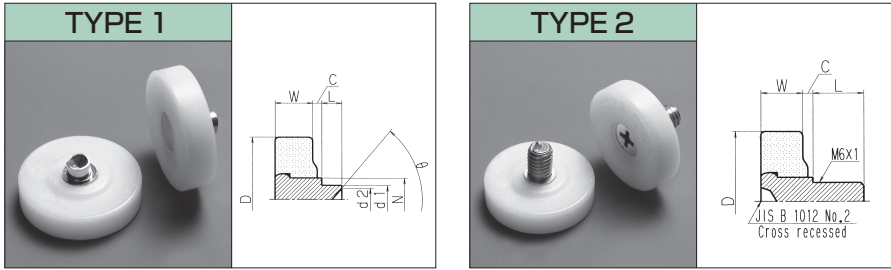

Code	Part No.	D _{-0.1} ⁰ [mm]	d1 _{-0.1} ⁰ [mm]	W _{-0.2} ⁰ [mm]	C ^{±0.4} [mm]	L ^{±0.2} [mm]	(d2×θ) ^{*1}	N [mm]	Type	Q'ty [pcs/box]	Gross Weight [kg/box]
240012	DL-16-A0.5	16	4	5	0.5	3.6	nothing	(7.6)	1	2,500	3.2
240021	DL-19-A1.6	19	5	6.6	1.6	3.5	φ4×100°	(7.6)	1	2,000	10.4
240040	DL-22-A1.6	22	5	6.6	1.6 ^{±0.5}	3.5	φ4×100°	(7.6)	1	1,000	6.5
240080	DL-26-A1.6	26	5	6.6	1.6	3.5	φ4×100°	(7.6)	1	1,000	7.5
240120	DL-19-B1.6	19	—	6.6	1.6	8 ^{±0.5}	—	(7.6)	2	1,500	9.0
240140	DL-22-B1.6	22	—	6.6	1.6	8 ^{±0.5}	—	(7.6)	2	1,000	7.4
240159	DL-22-B2.6-7170	22	—	6.7 ^{±0.2}	2.6	8 ^{±0.5}	—	(7.6)	2	1,000	8.3
240145	DL-22-B5	22	—	6.7 ^{±0.2}	5	8 ^{±0.5}	—	(7.8)	2	1,000	9.9
240152	DL-22-B8.7	22 ^{±0.2}	—	7 ^{±0.2}	8.7	11 ^{±0.5}	—	(7.8)	2	1,000	11.7
240180	DL-26-B1.6	26	—	6.6	1.6	8 ^{±0.5}	—	(7.6)	2	1,000	9.0

*1 参考値 Reference Dimension

*2 上記以外のサイズ・形状につきましては、弊社までご相談ください。

Each limiting size can be changed for practical application. Please ask our engineer for further information.

ER (帯電防止) Electrification Prevention

特長 1. アウターレースに導電性樹脂、潤滑剤に導電グリスを採用することにより、ベアリングの静電気の帯電を防止します。

FEATURE 1. Electrification of static electricity of bearings is prevented by adopting conductive resin for outer races and electric conduction grease.

Code	Part No.	D [mm]	W [mm]	C ^{±0.4} [mm]	L ^{±0.5} [mm]	N [mm]
720104	ER-19-B0.5	19 _{-0.1} ⁰	6 ^{±0.2}	0.5	8	(8.2)
720101	ER-22-B2	22 ^{±0.2}	7 _{-0.2} ⁰	2	8	(9.5)
720102	ER-22-B6	22 ^{±0.2}	7 _{-0.2} ⁰	6	8	(9.5)
720103	ER-26-B0.5	26 _{-0.1} ^{+0.3}	7 _{-0.3} ⁰	0.5	8	(9.5)

※仕様は、弊社までご相談ください。
 ※他のサイズでも制作検討致します。
 ※上記は受注生産品です。

※Please ask our engineer for further information.
 ※Each limiting size can also be supplied.
 ※These products manufactured to order.

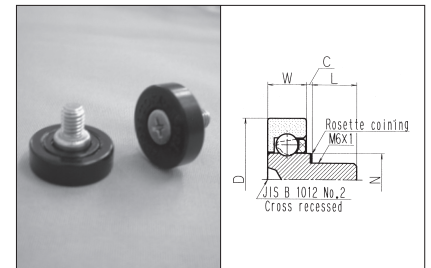

電気抵抗値 (参考データ)
 Electric resistance value (reference)

単位: kΩ
 unit

sample	1	2	3	4	平均値 average
電気抵抗値	174.8	221.8	221.5	131.3	187.4

※ラジアル荷重49N (5kgf) をかけ、3分間静止後、アウターレースとインナーレース間で電気抵抗値を測定。
 ※An electrical resistance value of the bearing between outer race and inner race is measured after applying radial load, 49N(5kgf), to the bearings for 3minutes.

IN (高荷重/金属インサート成形品/PAタイヤ)

RoHS

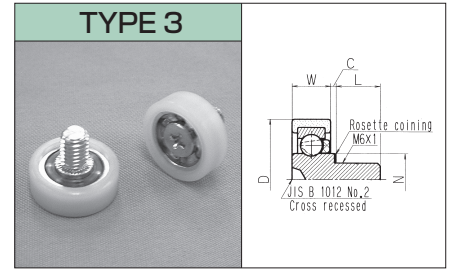
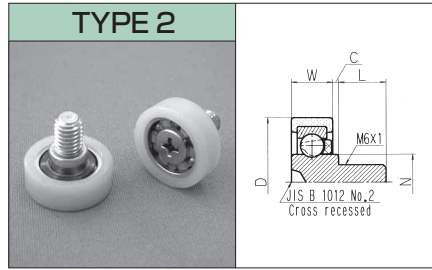
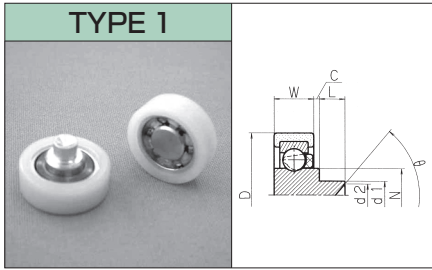

Code	Part No.	D _{-0.3} ⁰ [mm]	d1 _{-0.1} ⁰ [mm]	W ^{±0.2} [mm]	C ^{±0.4} [mm]	L ^{±0.2} [mm]	(d2×θ) ^{*1}	N [mm]	Load ^{*2} [N] (kgf)	Type	Q'ty [pcs/box]	Gross Weight [kg/box]
220000	IN-19-A1.5	19	5	7	1.5	3.5	φ4.4×120°	(8.2)	49 (5)	1	1,500	7.4
220011	IN-19-B1	19	—	7	1	8 ^{±0.5}	—	(8.2)	196 (20)	2	1,500	12.2
220013	IN-19-B2.7	19	—	7	2.7	8 ^{±0.5}	—	(8.2)	196 (20)	2	1,500	13.4
220014	IN-19-B3	19	—	7	3	8 ^{±0.5}	—	(8.2)	196 (20)	2	1,500	13.5
220010	IN-19-B0.5	19	—	7	0.5	8 ^{±0.5}	—	(8.2)	196 (20)	3	1,500	11.9
220012	IN-19-B1.5	19	—	7	1.5	8 ^{±0.5}	—	(8.2)	196 (20)	3	1,500	12.5

*1 参考値 Reference Dimension *2 許容荷重 (毎分300回 回転時) Allowable Load at 300min⁻¹ (300r.p.m)

*3 上記以外のサイズ・形状につきましては、弊社までご相談ください。Each limiting size can be changed for practical application. Please ask our engineer for further information.

ID (高荷重/金属インサート成形品/POMタイヤ)

RoHS

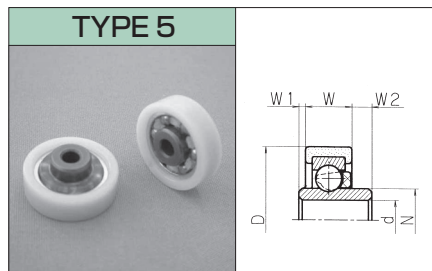
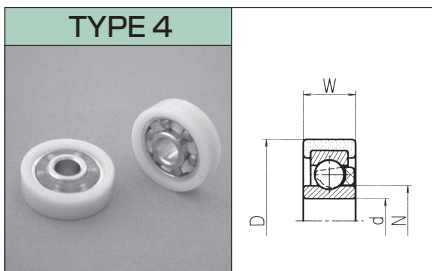
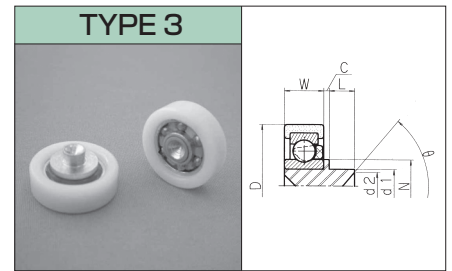
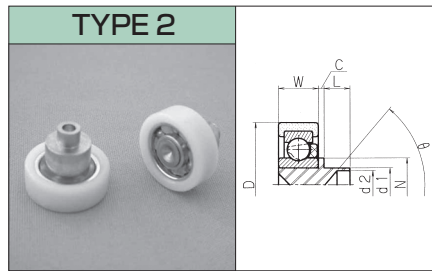
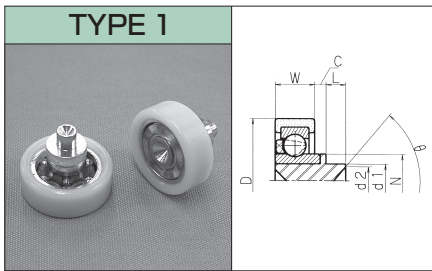

Code	Part No.	D _{-0.1} ⁰ [mm]	d _{+0.1} ⁰ [mm]	d1 _{-0.1} ⁰ [mm]	W ^{±0.2} [mm]	C ^{±0.4} [mm]	L ^{±0.2} [mm]	(d2×θ) ^{*1}	W1 ^{*1} [mm]	W2 ^{*1} [mm]	N [mm]	Load ^{*2} [N] (kgf)	Type	Q'ty [pcs/box]	Gross Weight [kg/box]
221101	ID-18.8-AH5	18.8	—	4	7	5	3.5	φ3 × 90°	—	—	(8.2)	343 (35)	1	1,500	13.0
221100	ID-18.8-AH5-5	18.8	—	4	7	5	5	φ3 × 90°	—	—	(8.2)	343 (35)	1	1,500	13.4
221102	ID-19-AH2.5	19 _{-0.3} ⁰	—	5	7	2.5	3.5	φ3 × 120°	—	—	(10.0)	343 (35)	2	1,500	12.9
221103	ID-19-AH5.5	19 _{-0.3} ⁰	—	5	7	5.5	3.5	φ3 × 120°	—	—	(10.0)	343 (35)	2	1,500	15.9
221110	ID-24-AH1-3.6	24 ^{±0.2}	—	6	8	1	3.6	φ5.5 × 90°	—	—	(13.0)	343 (35)	3	1,000	12.3
221301	ID-19-H6	19 _{-0.3} ⁰	6	—	7	—	—	—	—	—	(8.2)	343 (35)	4	2,000	10.5
221303	ID-22-H6	22	6	—	7	—	—	—	—	—	(9.5)	343 (35)	4	1,500	22.5
221304	ID-22-H4W (0.5) 3	22	4	—	7	—	—	—	0.5	3	(9.5)	343 (35)	5	1,000	10.2

*1 参考値 Reference Dimension *2 許容荷重 (毎分300回 回転時) Allowable Load at 300min⁻¹ (300r.p.m)

*3 上記以外のサイズ・形状につきましては、弊社までご相談ください。Each limiting size can be changed for practical application. Please ask our engineer for further information.

IDS (高荷重/金属インサート成形品)

RoHS

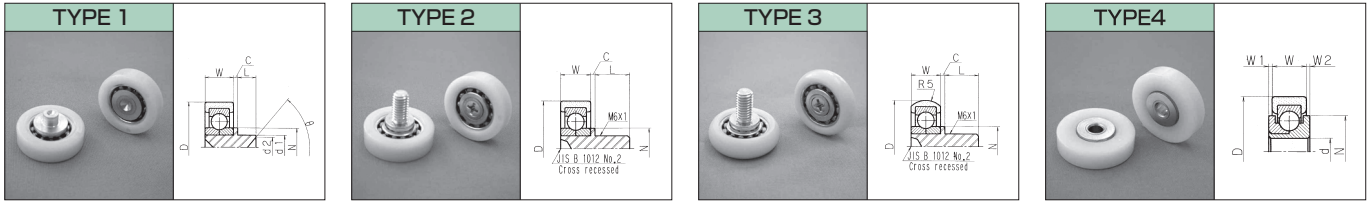

Code	Part No.	D ^{±0.1} [mm]	d ^{+0.1} ₀ [mm]	d1 ^{-0.1} ₀ [mm]	W ^{±0.2} [mm]	C ^{±0.4} [mm]	L ^{±0.2} [mm]	^{*1} (d2×θ)	W1 ^{*1} [mm]	W2 ^{*1} [mm]	N [mm]	Load ^{*2} [N] (kgf)	Type	Q'ty [pcs/box]	Gross Weight [kg/box]
221400	IDS-22-A1	22	—	5	7	1	3.5	φ2.5×90°	—	—	(11.0)	392 (40)	1	1,000	12.4
221401	IDS-22-A2.5	22	—	5	7	2.5	3.5	nothing	—	—	(9.0)	392 (40)	1	1,000	14.0
221403	IDS-22-A3.4-4.5	22	—	5.1	7	3.4	4.5	φ2.5×90°	—	—	(9.5)	392 (40)	1	1,000	13.4
221450	IDS-26-A1.5	26	—	6	8	1.5	3.5	φ5.5×90°	—	—	(11.0)	588 (60)	1	800	15.5
221504	IDS-22-B1.5-8	22	—	—	7	1.5	8 ^{±0.5}	—	—	—	(11.0)	392 (40)	2	1,000	13.2
221501	IDS-22-B1.5-11	22	—	—	7	1.5	11 ^{±0.5}	—	—	—	(11.0)	392 (40)	2	1,000	15.3
221505	IDS-22-B4-7	22	—	—	7	4	7 ^{±0.5}	—	—	—	(9.5)	392 (40)	2	1,000	14.5
221518	IDS-22-B11	22	—	—	7	11	8 ^{±0.5}	—	—	—	(9.5)	392 (40)	2	1,000	18.6
221600	IDS-26-B2-11	26	—	—	8	2	11 ^{±0.5}	—	—	—	(11.0)	588 (60)	2	500	10.2
221603	IDS-26-B5-9	26	—	—	8	5 ^{±0.5}	9 ^{±0.5}	—	—	—	(9.5)	588 (60)	2	500	11.1
221650	IDS-30-B2-11	30	—	—	9	2	11 ^{±0.5}	—	—	—	(11.0)	588 (60)	2	500	12.1
221700	IDS0-26-B2-11	26 ^{-0.2} ₀	—	—	8	2	11 ^{±0.5}	—	—	—	(11.0)	588 (60)	3	500	10.2
221901	IDS-26-H6.35W0.8	26	6.35	—	8	—	—	—	0.8	0.8	(17.0)	294 (30)	4	800	16.3
221954	IDS-35-H6.35W0.26	35 ⁰ _{-0.1}	6.35	—	9	—	—	—	0.26	0.26	(17.0)	294 (30)	4	500	13.3

*1 参考値 Reference Dimension

*2 許容荷重 (毎分 300 回 回転時) Allowable Load at 300min⁻¹ (300r.p.m)

*3 上記以外のサイズ・形状につきましては、弊社までご相談ください。Each limiting size can be changed for practical application. Please ask our engineer for further information.

DT (樹脂巻きベアリング)

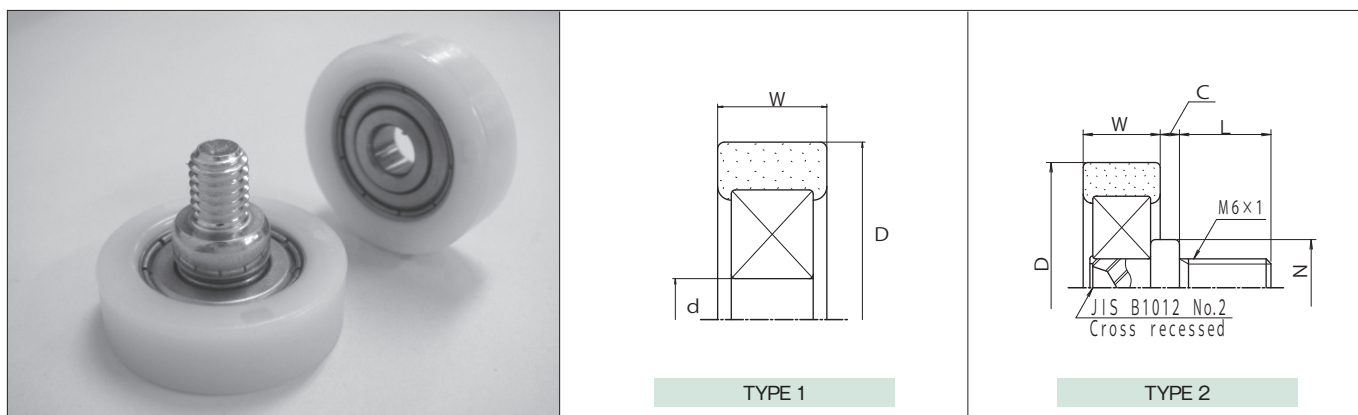

■ 特 長

1. 金属ベアリングをポリアセタール樹脂でインサート成形したベアリングです。
2. 回転精度 (振れとガタツキが小さい) に優れています。
3. 高荷重での走行音を小さくすることができます。

CODE	Part No.	D (mm)	d (mm)	W (mm)	C (mm)	L (mm)	N (mm)	許容荷重 [N] (kgf)	TYPE
110071	DT-17-604ZZ-CB	17	(4)	6	-	-	-	98 (10)	1
110200	DT-18-L1260ZZ	18	(6)	6	-	-	-	392 (40)	1
110201	DT-19-L1260ZZ	19	(6)	6	-	-	-	392 (40)	1
110202	DT-20-L1260ZZ	20	(6)	6	-	-	-	392 (40)	1
110070	DT-22-688ZZ	22	(8)	7	-	-	-	441 (45)	1
110203	DT-24-H6-626ZZ	24	(6)	8	-	-	-	490 (50)	1
110056	DT-26-H6-626ZZ	26	(6)	8	-	-	-	490 (50)	1
110204	DT-30-608ZZ	30	(8)	9	-	-	-	686 (70)	1
110205	DT-35-608ZZ	35	(8)	9	-	-	-	784 (80)	1
110100	DT-18-BH1-L1260ZZ	18	-	6	1	8	(9)	392 (40)	2
110101	DT-19-BH1-L1260ZZ	19	-	6	1	8	(9)	392 (40)	2
110102	DT-20-BH1-L1260ZZ	20	-	6	1	8	(9)	392 (40)	2
110103	DT-22-BH1-688ZZ	22	-	7	1	8	(12)	441 (45)	2
110104	DT-24-BH1-626ZZ	24	-	8	1	8	(9)	490 (50)	2
110105	DT-26-BH1-626ZZ	26	-	8	1	8	(9)	490 (50)	2
110106	DT-30-BH1-608ZZ	30	-	9	1	8	(12)	686 (70)	2
110107	DT-35-BH1-608ZZ-9	35	-	9	1	8	(12)	784 (80)	2
110058	DT-26-BH0.5-626ZZ	26	-	8	0.5	8	(10)	490 (50)	2
110057	DT-26-BH2-9.5-626ZZ	26	-	8	2	9.5	(10)	490 (50)	2
110060	DT-26-BH4-626ZZ	26	-	8	4	8	(10)	490 (50)	2
110059	DT-26-BH6-14-626ZZ	26	-	8	6	14	(10)	490 (50)	2

PE

超高分子量ポリエチレン
ULTRA-HIGH MOCECULAR WEIGHT POLYETHYLENE
(耐薬品性ベアリング ANTI-ACID.ANTI-ALKALI BEARINGS)

RoHS

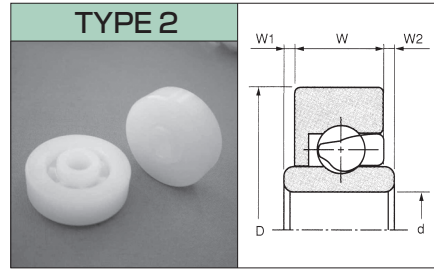
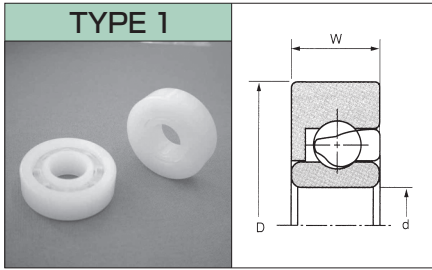

Code	Part No.	D _{-0.1} ⁰ [mm]	d ₀ ^{+0.12} ₋₀ [mm]	W _{-0.2} [mm]	W1 ^{*1} [mm]	W2 ^{*1} [mm]	Type	Q'ty [pcs/box]	Gross Weight [kg/box]	BALL ^{*2}
250126	PE-35-SHP15	35	15 ^{+0.15} ₀	11	—	—	1	400	5.3	S
250010	PE-35-SHP8W1.75	35	8	11	1.75	1.75	2	300	3.7	S
250017	PE-35-SHP17W1.75	35	17 ^{+0.2} _{-0.01}	11	1.75	1.75	2	400	4.8	S
250100	PE-26-PHP10	26 _{-0.2} ⁰	10	8	—	—	1	1,000	2.9	P
250121	PE-30-PHP10	30	10	9	—	—	1	500	2.2	P
250124	PE-32-PHP12	32	12 ^{+0.2} ₀	10	—	—	1	500	3	P
250127	PE-35-PHP15	35	15 ^{+0.15} ₀	11	—	—	1	400	2.5	P
250132	PE-47-PHP20	47	20	14	—	—	1	150	4	P
250011	PE-35-PHP8W1.75	35	8	11	1.75	1.75	2	300	3.4	P
250122	PE-30-GHP10	30	10	9	—	—	1	500	6	G
250131	PE-40-GHP17	40	17	12	—	—	1	300	3.7	G
250012	PE-35-GHP8W1.75	35	8	11	1.75	1.75	2	300	3.1	G
250019	PE-35-GHP17W1.75	35	17 ^{+0.2} _{-0.01}	11	1.75	1.75	2	400	3.5	G

*1 参考値 Reference Dimension

*2 ボール材質 S : ステンレス鋼、P : ポリエチレン、G : ガラス (アウターレース及びインナーレースはいずれも超高分子量ポリエチレン)

Ball Material S : Stainless Steel, P : Polyethylene, G : Glass (Outer and Inner Race : Ultra-high Molecular Weight Polyethylene)

*3 上記以外のサイズ・形状につきましては、弊社までご相談ください。Each limiting size can be changed for practical application. Please ask our engineer for further information.

※潤滑剤は使用しておりません。These products use no Lubricant.

※上記は受注生産品です。These products manufactured to order.

プラスチックの耐薬品性について Durability of Plastics against Chemical Affections.

表1 : プラスチックの耐酸・耐アルカリ性 Table No.1 : Durability of Plastics against Acid and Alkali

	Polyacetal(POM)	Polyamid (PA)	Polyethylene (PE)	Polypropylene (PP)
液体アンモニア Liquid Ammonia	○	○	○	○
水酸化カルシウム Calcium Hydroxide	○	○	○	○
水酸化カリウム Potassium Hydroxide	○	○	○	○
水酸化ナトリウム Sodium Hydroxide	30%30°C	X	○	○
	30% RT	○	○	○
	10% RT	△	○	○
シュウ酸 Oxalic Acid	○	○	○	○
酢酸 Acetic Acid	50% RT	△	○	○
塩酸 Hydrochloric Acid	38% RT	X	○	○
	10% RT	○	○	○
硝酸 Nitric Acid	発煙 RT FumingRT	X	X	X
	61% RT	X	△	△
	10% RT	△	△	○
硫酸 Sulphuric Acid	発煙 RT FumingRT	X	X	△
	98% RT	X	△	△
	10% RT	△	○	○
クロム酸 Chromic Acid	25% RT	X	○	△

ポリエチレン樹脂は、特に酸・アルカリに侵されにくい特長がありますが、温度を上げたり、高濃度になると不安定になりますので、ご使用にあたっては注意する必要があります。

Shown on table No.1 is durability of each material such as Polyacetal, Polyamid, Polyethylene and Polypropylene respectively against Acid and Alkali.

表2 : プラスチックの耐溶剤、耐油、耐ガス、耐海水性 Table No.2 : Durability of plastics against Solvent, Oil, Gasses & Sea-Water

	Polyacetal(POM)	Polyamid (PA)	Polyethylene (PE)	Polypropylene (PP)
海水 Sea-Water	○	*	○	○
亜硫酸ガス Sulfur Dioxide Gas	○	○	○	○
炭酸ガス Carbonic Acid Gas	○	○	○	○
アンモニア Ammonia	○	○	○	○
石油 Petroleum	○	○	△	○
ベンジン Benzine	△	○	△	△
ホルムアルデヒド Holmaldehyde	○	△	○	○
エチルアルコール Ethyl Alcohol	○	○	○	○
クレゾール Cresol	○	X	○	○

海水に対しては、耐水性だけを考慮すれば良いのですが、*印ポリアミド樹脂は吸水率が大きいので、アウターレース・インナーレース・ボールの材料としては使用に適しません。

Bearings used in seawater must possess anti-corrosiveness to Water, Whereas the asterisked (*) Polyamid resin is too water-absorptive to be used for outer races inner races or balls in this field application.

「プラスチックの耐久性」大石不二夫著/機工業調査会発行より (但し海水は除く)

(記号の説明)

○ : 優……まったく、あるいはほとんど侵されず、実用に耐える。
○ : 良……若干作用を受けるが、条件により実用に供せる。
△ : 可……作用を受けるので、実用には好ましくない。
× : 不可……侵されるので、使用に適さない。
RT : 室温

(Explanation of Codes)

○ : Fair ……Sheer free from any corrosive affect. Durable enough for field application
○ : Good ……Slightly yielding to external influence, but will stand field application depending upon the ambient condition.
△ : Average…Yielding and not applicable.
× : Improper…Easily gets affected and not usable.
RT : Room Temperature.

PK·PV

RoHS

(耐薬品・耐熱性ベアリング CHEMICAL RESISTANCE AND HEAT RESISTANCE BEARINGS)

従来の弊社PEベアリングよりも耐薬品・耐熱性が優れたベアリングです。

化学プロセス工業の搬送機器、医療機器、半導体洗浄機、その他薬液中、高温下での搬送機器等にお奨めしております。

Much better chemical and heat resistance than conventional PE SERIES BEARINGS.

Suitable applications are transportation system at chemical process, medical equipment and semiconductor washing and cleaning equipment etc. which are in use with chemical liquid, and under high temperature.

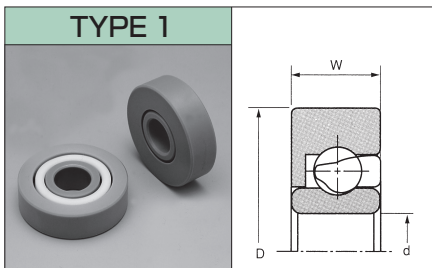

Code	Part No.	D _{-0.1} ⁰ [mm]	d ^{+0.12} ₀ ¹² [mm]	W _{-0.2} ⁰ [mm]	ボール材質 *1 Balls material	アウターレース・インナーレース材質 *2 Outer and inner races material	リテーナ材質 *3 Retainer material
801009	PK-30-GHP10	30	10	9	ガラス	PEEK	PTFE
—	PV-30-GHP10	30	10	9	ガラス	PVDF	PTFE
802016	PK-32-GHP12	32	12	10	ガラス	PEEK	PTFE
—	PV-32-GHP12	32	12	10	ガラス	PVDF	PTFE
802018	PK-35-GHP15	35	15	11	ガラス	PEEK	PTFE
—	PV-35-GHP15	35	15	11	ガラス	PVDF	PTFE
802012	PK-28-CHP12	28	12	8	Al ₂ O ₃	PEEK	PTFE
802013	PK-30-CHP10	30	10	9	Al ₂ O ₃	PEEK	PTFE
802014	PK-32-CHP15	32	15	9	Al ₂ O ₃	PEEK	PTFE
802015	PK-42-CHP20	42	20	12	Al ₂ O ₃	PEEK	PTFE

*1 ボール材質 G: ガラス, C: アルミナ Ball Material G: Glass, C: Alumina
 *2 アウターレース・インナーレース材質 PEEK: ポリエーテルエーテルケトン, PVDF: ポリフッ化ビニリデン Outer and inner races Material PEEK: Polyetheretherketone, PVDF: Polyvinylidene fluoride.
 *3 リテーナ材質 PTFE: ポリテトラフルオロエチレン Retainer material PTFE: Polytetrafluoroethylene.
 *4 上記以外のサイズ・形状につきましては弊社までご相談ください。 Each limiting size can be changed for practical application. Please ask our engineer for further information.
 ※潤滑剤は使用していません。 These products use no lubricant.
 ※上記は受注生産品です。 These products manufactured to order.

材質 Materials	耐薬品性樹脂 Chemical resistance Resin					その他の樹脂 Other Resin			
	P T F E	P C T F E	P V D F	P E E K	U H M W P E (超 高 分 子 量)	P A	P O M	P P	P V C (硬 質)
耐熱性 (°C) [実用レベル] Temperature Resistance [°C]	130	80	80	130	60	70	50	50	35
機 械 的 性 質 Mechanical	△	○	○	◎	○	○	◎	○	○
電 気 的 性 質 Electrical	◎	○	○	◎	△	△	△	◎	△
耐薬品性 Chemical proof	酸 Acid	◎	◎	○	○	×	×	○	○
	アルカリ Alkalis	◎	◎	○	◎	×	△	○	○
	溶剤 Solvents	◎	○	○	◎	△	×	△	△

※判定は、素材メーカーカタログや学術文献書籍を参考に
 したもので弊社にて実証したものではありません。
 * A judgements are modeled after a material maker
 catalog and scientific reference books and is not what was
 proved by our company.

(記号の説明)

◎: 優……まったく、あるいはほとんど侵されず、実用に耐える。
 ○: 良……若干作用を受けるが、条件により実用に供せる。
 △: 可……作用を受けるので、実用には好ましくない。
 ×: 不可……侵されるので、使用に適さない。

(Explanation of Codes)

◎: Fair……Sheer free from any corrosive affect. Durable enough for field application
 ○: Good……Slightly yielding to external influence, but will stand field application depending upon
 the ambient condition.
 △: Average……Yielding and not applicable.
 ×: Improper……Easily gets affected and not usable.

S・SS

(ALL STAINLESS STEEL BEARINGS) **RoHS**

アウターレース、インナーレース、ボールにステンレスを使用したベアリングです。

These bearings are made of stainless steel.

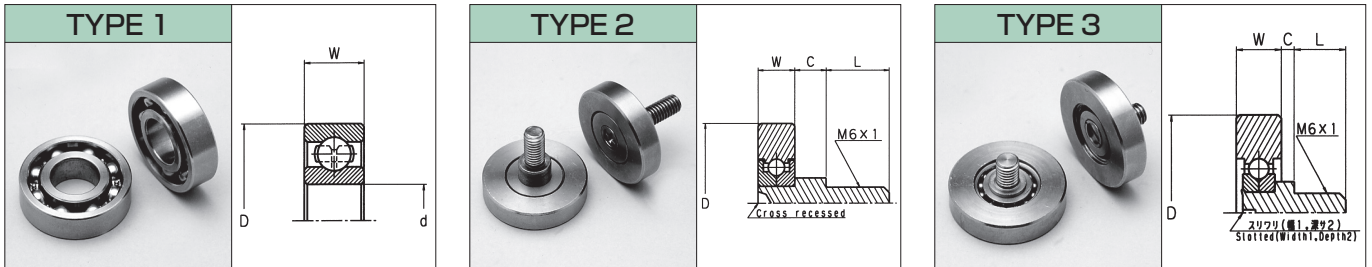

Code	Part No.	D _{-0.03} [mm]	d ^{+0.05} ₀ [mm]	W _{-0.05} [mm]	C ^{±0.4} [mm]	L ^{±0.2} [mm]	アウターレース 材質 Outer races material	インナーレース 材質 Inner races material	シャフト 材質 Shaft material	リテーナ 材質 Retainer material	ボール 材質 Balls material	Type
233002	S-16-SHS8-304-GN	16	8	4	—	—	SUS304	SUS304	—	SUS304	SUS304	1
233003	S-22-SHS8-304-GN	22	8	7	—	—	SUS304	SUS304	—	SUS304	SUS304	1
233007	S-22-SHS10-304-GN	22	10	6	—	—	SUS304	SUS304	—	SUS304	SUS304	1
233008	S-24-SHS12-304-GN	24	12	6	—	—	SUS304	SUS304	—	SUS304	SUS304	1
233009	S-26-SHS9-304-GN	26	9	8	—	—	SUS304	SUS304	—	SUS304	SUS304	1
233000	S-28-SHS12-304-GN	28	12	8	—	—	SUS304	SUS304	—	SUS304	SUS304	1
233001	S-28-SHS15-304-GN	28	15	7	—	—	SUS304	SUS304	—	SUS304	SUS304	1
233005	S-30-SHS10-304-GN	30	10	9	—	—	SUS304	SUS304	—	SUS304	SUS304	1
233004	S-30-SHS17-304-GN	30	17	7	—	—	SUS304	SUS304	—	SUS304	SUS304	1
233006	S-32-SHS12-304-GN	32	12	10	—	—	SUS304	SUS304	—	SUS304	SUS304	1
232050	SS-22-SBS2	22 ^{-0.1} ₀	—	7 ^{±0.2}	2	8	SUS303	SUS303	SUS305	—	SUS304	2
232055	SS-30-SBS6-12	30 ^{±0.1}	—	7 ^{-0.2} ₀	6	12	SUS303	SUS303	SUS305	—	SUS440C	2
232060	SS-30-SBS0.5	30 ^{-0.1} ₀	—	7 ^{-0.2} ₀	0.5	8	SUS303	SUS303	SUS303	—	SUS304	3

※上記以外のサイズ・形状につきましては、弊社までご相談ください。Each limiting size can be changed for practical application. Please ask our engineer for further information.
 ※上記は受注生産です。These products manufactured to order.

ステンレス鋼の耐腐食性 ANTI-CORROSIVENESS OF STAINLESS STEEL

表 1 : ステンレス鋼の耐腐食性 Table No.1: Anti corrosiveness of Stainless Steel.

	SUS 304	SUS 316
海水 Sea-Water	A *	A *
亜硫酸(飽和)20℃ Sulfurous Acid (Saturation) 20℃	C	B
アンモニア水 Liquid Ammonia	A	A
沸騰 Boiling	A	A
20℃	A	A
エチルアルコール Ethyl Alcohol	A	A
沸騰 Boiling	A	A
20℃	A	A
アンモニア Ammonia	D	A
ガス高温 Gas-High Temperature	D	A
全濃度 20℃ Whole Density 20℃	A	A
水酸化ナトリウム Sodium Hydroxide	A	A
シュウ酸 10% 20℃ Oxalic Acid 10% 20℃	A	A
酢酸 50% 20℃ Acetic Acid 50% 20℃	A	A
塩酸全濃度 20℃ Hydrochloric Acid Whole Density 20℃	E	E
硝酸 Nitric Acid	B	B
65%沸騰 65%Boiling	B	B
20%20℃	A	A
50%20℃	D	C
硫酸 Sulphuric Acid	E	C
5%沸騰 5%Bolling	E	C
5%20℃	C	B

ステンレス鋼は、耐腐食性については一般に良好ですが、特殊環境や条件によっては、孔食、応力腐敗割れなどを起こすことがありますので、ご使用の際は注意が必要です。表以外の環境、条件でのご使用にあたっては弊社へお問い合わせください。

Stainless steel, as the name itself expresses, generally quite effective in anti-corrosiveness. However, it occasionally gets corroded and cracked by a stress at the corroded portion, eventually precautions must be taken when it will be used.

In case it will be used in surroundings and conditions other than stipulated in the table, please consult before use.

大同特殊鋼(株)発行カタログより

(記号の説明)

記号 腐食減量 (%)
 A..... ≤0.1 } 使用に適す
 B..... 0.1~1.0 }
 C..... 1.0~3.0 } やや腐食される
 D..... 3.0~10.0 } 腐食される
 E..... ≥10.0 } かなり腐食される
 *..... 乾燥すると点食を生じる

(Explanation of Codes)

code Weight Reduction by Corrosion
 A..... ≤0.1 } usable
 B..... 0.1~1.0 }
 C..... 1.0~3.0 } Slightly corroded
 D..... 3.0~10.0 } Gets corroded
 E..... ≥10.0 } Badly corroded
 *..... Corrosion spots appear when dehydrated

C

RoHS

耐薬品性ベアリングでドライ（無潤滑）使用。非磁性のためマグネットの影響を受けません。
 主な用途としてエッチング装置や洗浄装置、メッキ装置、医療検査装置等にお奨めしております。
 Chemical resistant bearing without grease. No influence by the magnet (non magnetis).
 Recommended for the use of etching, cleaning, coating, medical testing equipments.

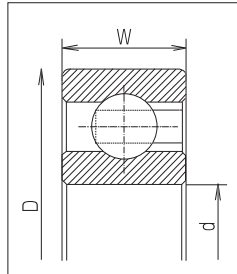
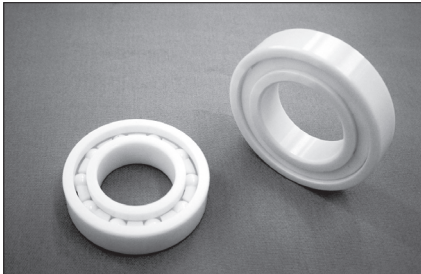

Code	Part No.	JIS	D _{-0.02} [mm]	d ^{+0.02} [mm]	W _{-0.1} [mm]	ボール 材質 Balls material	アウターレース インナーレース材質 Outer and Inner races material	リテーナー材質 Retainer material
250414	C-26-CHC10	6000	26	10	8	ZrO ₂	ZrO ₂	PTFE
250415	C-28-CHC12	6001	28	12	8	ZrO ₂	ZrO ₂	PTFE
250416	C-30-CHC10	6200	30	10	9	ZrO ₂	ZrO ₂	PTFE
250405	C-32-CHC12	6201	32	12	10	ZrO ₂	ZrO ₂	PTFE
250412	C-32-CHC15	6002	32	15	9	ZrO ₂	ZrO ₂	PTFE
250406	C-35-CHC15	6202	35	15	11	ZrO ₂	ZrO ₂	PTFE
250417	C-35-CHC17	6003	35	17	10	ZrO ₂	ZrO ₂	PTFE
250418	C-40-CHC17	6203	40	17	12	ZrO ₂	ZrO ₂	PTFE
250404	C-42-CHC20	6004	42	20	12	ZrO ₂	ZrO ₂	PTFE
250402	C-42-CHC30	6806	42	30	7	ZrO ₂	ZrO ₂	PTFE
250411	C-47-CHC20	6204	47	20	14	ZrO ₂	ZrO ₂	PTFE
250403	C-47-CHC25	6005	47	25	12	ZrO ₂	ZrO ₂	PTFE
250407	C-52-CHC25	6205	52	25	15	ZrO ₂	ZrO ₂	PTFE
250401	C-55-CHC30	6006	55	30	13	ZrO ₂	ZrO ₂	PTFE
250419	C-62-CHC30	6206	62	30	16	ZrO ₂	ZrO ₂	PTFE
250420	C-62-CHC35	6007	62	35	14	ZrO ₂	ZrO ₂	PTFE
250400	C-68-CHC40	6008	68	40	15	ZrO ₂	ZrO ₂	PTFE
250408	C-72-CHC35	6207	72	35	17	ZrO ₂	ZrO ₂	PTFE
250413	C-80-CHC40	6208	80	40	18	ZrO ₂	ZrO ₂	PTFE
250410	C-85-CHC45	6209	85 _{-0.03}	45 ^{+0.03}	19	ZrO ₂	ZrO ₂	PTFE

※内部隙間はC4以下（0.03以内）

※他のサイズもご相談下さい。

※材質 ボール、アウターレース・インナーレース：ジルコニア（ZrO₂） リテーナー：ポリテトラフルオロエチレン（PTFE）

※Inner gaps under C4 (within 0.03)

※Applicable in the different size.

※Material: Ball, outer race, inner race: zirconia (ZrO₂) retainer: polytetrafluoroethylene (PTFE)

部材の耐食性（選定目安） Corrosion resistivity (guide to select)

使用液 Use liquid	材質 Material	窒化ケイ素 Si ₃ N ₄	ジルコニア ZrO ₂	ポリテトラフルオロエチレン PTFE
塩水 Salt-Water		◎	◎	◎
水酸化カリウム Potassium Hydroxide		△	△	◎
水酸化ナトリウム Sodium Hydroxide		△	○	◎
ふっ酸 Hydrofluoric acid		△	▲	◎
リン酸 Phosphoric Acid		○	○	◎
硫酸 Sulphuric Acid		○	○	◎
塩酸 Hydrochloric Acid		△	○	◎
硝酸 Nitric Acid		○	○	◎

◎：侵されない

○：ほとんど侵されない

△：多少侵される可能性がある

▲：侵される可能性がある

◎：anticorrosive

○：hardly corrosive

△：slight corrosive

▲：possibility of corrosiveness

※薬液の耐食性は濃度・温度などで大きく異なりますので標記は目安として下さい。

（上記の表は文献資料を参考に作成したもので弊社にて確認したものではありません。）

※Chemical resistance should differ in the chemical concentration and temperature.

（above chart was made by the reference book, only use for reference）

UT (ウレタン巻 JIS ベアリング)

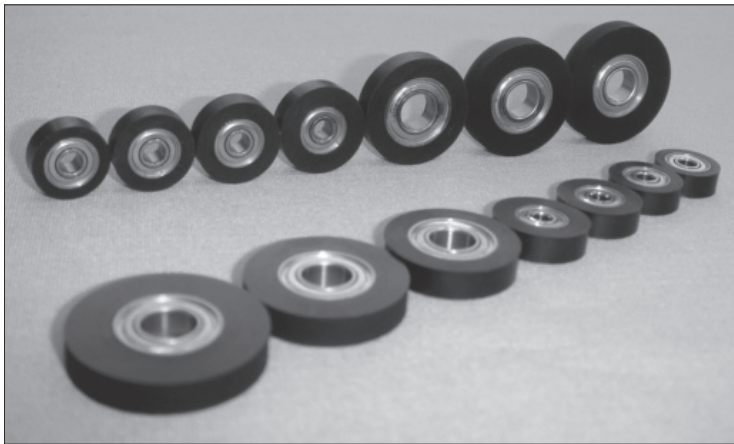

特長

1. JIS規格ベアリングにウレタンゴムを焼付接着したベアリングです。
2. タイヤ材質がウレタンゴムである為、走行音を小さくすることができます。

FEATURE

1. The polyurethane rubber is burned onto JIS bearing.
2. Because of the polyurethane rubber operational noise levels are very low.

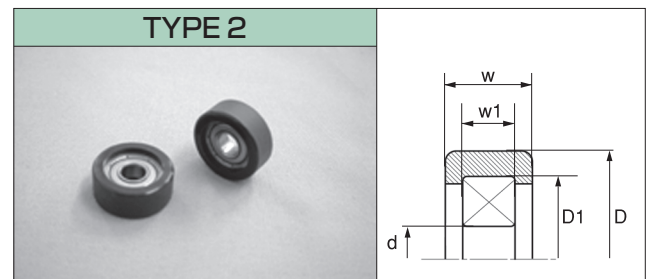
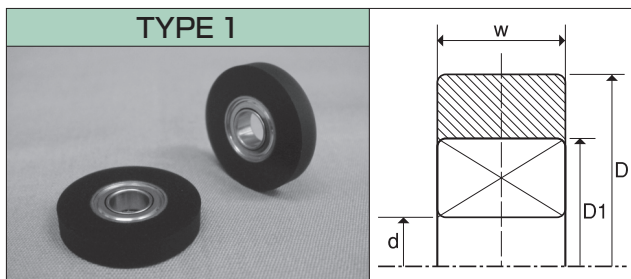

Code	Part No.	D ^{±0.1} [mm]	d [mm]	W ^{±0.2} [mm]	使用 JIS ベアリングサイズ		Load (N) ※2		TYPE
					D1 ※1 [mm]	W1 ※1 [mm]	[N]	[kgf]	
112000	UT-11-SHS3	11	(3)	4	8	4	—	—	1
112001	UT-12-SHS3	12	(3)	4	8	4	—	—	1
112002	UT-13-SHS3	13	(3)	4	8	4	—	—	1
112003	UT-14-SHS3	14	(3)	4	8	4	—	—	1
112004	UT-15-SHS4	15	(4)	5	13	5	—	—	1
112005	UT-16-SHS4	16	(4)	5	13	5	98 (10)	—	1
112006	UT-17-SHS4	17	(4)	5	13	5	98 (10)	—	1
112007	UT-18-SHS6	18	(6)	4	12	4	—	—	1
112008	UT-19-SHS6	19	(6)	4	12	4	—	—	1
112009	UT-20-SHS6	20	(6)	4	12	4	—	—	1
112010	UT-21-SHS6	21	(6)	4	12	4	—	—	1
112011	UT-22-SHS6	22	(6)	4	12	4	—	—	1
110032	UT-20-696ZZ	20 _{-0.03}	(6)	8	15	5	29.4 (3)	—	2

※1 参考値
 ※2 許容荷重 (毎分 300 回 回転時)
 ※ウレタンゴム材質 (TYPE1) : ポリエーテル系ウレタンゴム
 (TYPE2) : ポリエステル系ウレタンゴム
 ※ウレタンゴム硬度 : 90±3° (JIS A)
 ※上記は受注生産品です。

※1 Reference Dimension
 ※2 Allowable Load at 300min⁻¹(300r.p.m)
 ※Polyurethane rubber material (TYPE1) : Polyester type polyurethane rubber.
 (TYPE2) : Polyester type polyurethane rubber
 ※Hardness for the polyurethane : 90±3° (JIS A)
 ※These products are made to order

A·AS (鋼製ベアリング)

RoHS

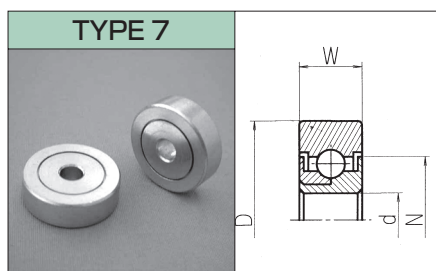
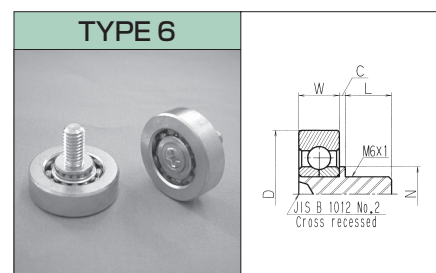
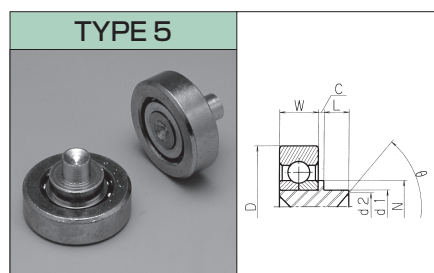
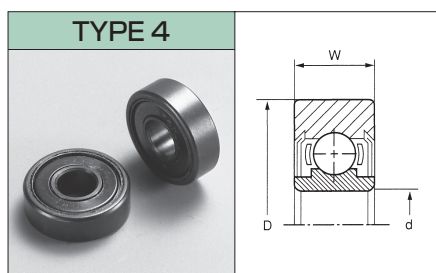
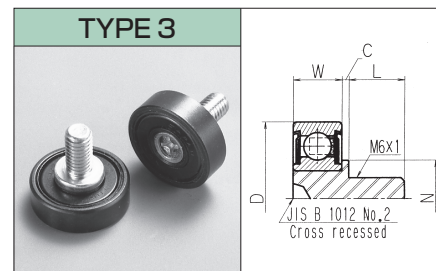
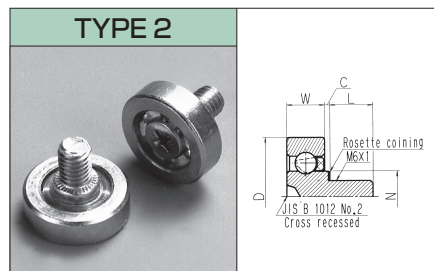
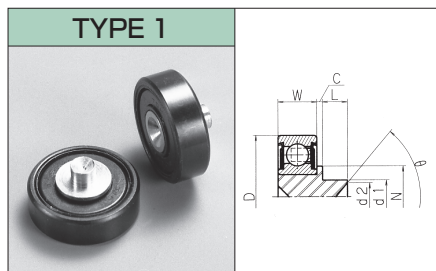

Code	Part No.	D ^{+0.1} [mm]	d ^{+0.1} [mm]	d1 ⁰ _{-0.1} [mm]	W ^{±0.2} [mm]	C ^{±0.4} [mm]	L ^{±0.2} [mm]	(d2×θ) ^{*1}	N [mm]	Load ^{*2} [N] (kgf)	Type	Q'ty [pcs/box]	Gross Weight [kg/box]
230050	A-22-AH1-3.4	22	—	5	7	1	3.4	φ4.5×110°	(11.0)	784 (80)	1	1,000	16.2
230203	A-19-B1	19	—	—	6	1	8 ^{±0.5}	—	(8.2)	490 (50)	2	1,000	12.1
230204	A-19-B2	19	—	—	6	2	8 ^{±0.5}	—	(8.2)	490 (50)	2	1,000	12.7
230207	A-19-B2.7	19	—	—	6	2.7	8 ^{±0.5}	—	(8.2)	490 (50)	2	1,000	12.8
230251	A-22-BH2.8-11	22	—	—	7	2.8	11 ^{±0.5}	—	(11.0)	784 (80)	3	1,000	18.0
800000	A-608ZZ-5	22	8	—	7	—	—	—	—	784 (80)	4	1,000	10.8
231010	AS-19-A0.5-5	19 ^{±0.05}	—	5	6 ^{±0.1}	0.5 ^{±0.3}	5	φ4.5×100~130°	(9.5)	490 (50)	5	1,500	19.0
231050	AS-22-A1.5	22	—	6	8	1.5	3.5	φ5.5×90°	(11.0)	686 (70)	5	1,000	18.0
231052	AS-22-A1.5-5.5	22	—	6	8	1.5	5.5	φ5 ×110°	(11.0)	686 (70)	5	1,000	20.1
231150	AS-26-A1.5	26	—	6	8	1.5	3.5	φ5.5×90°	(11.0)	686 (70)	5	800	23.2
231203	AS-22-B0.5-9.5	22	—	—	8	0.5	9.5 ^{±0.5}	—	(11.0)	686 (70)	6	1,000	19.9
231204	AS-22-B2-11	22	—	—	8	2	11 ^{±0.5}	—	(11.0)	686 (70)	6	1,000	21.5
231250	AS-24-B0.5-9.5	24	—	—	8	0.5	9.5 ^{±0.5}	—	(11.0)	686 (70)	6	500	12.3
231300	AS-26-B2-11	26	—	—	8	2	11 ^{±0.5}	—	(11.0)	686 (70)	6	500	15.5
231402	AS-608ZZ-2	22	8	—	7	—	—	—	(17.0)	294 (30)	7	500	7.6
231405	AS-26-H6	26	6	—	8 ^{±0.3}	—	—	—	(17.0)	294 (30)	7	800	27.8

*1 参考値 Reference Dimension

*2 許容荷重 (毎分 300 回 回転時) Allowable Load at 300min⁻¹ (300r.p.m)

*3 上記以外のサイズ・形状につきましては、弊社までご相談ください。

Each limiting size can be changed for practical application. Please ask our engineer for further information.

TAS (強靱性) RoHS

特長 1.強靱性で、破壊しにくいベアリングです。

FEATURE 1.The TAS bearings are hard to destroy and toughness since new technology is used for the bearings nature and shock resistance.

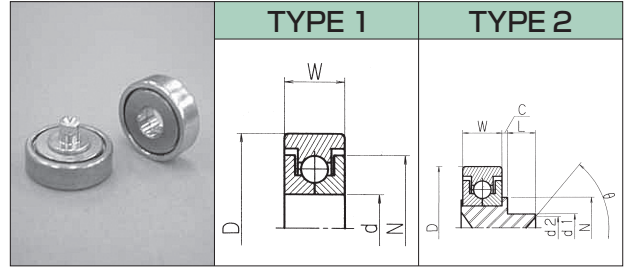

Code	Part No.	D _{-0.1} ⁰ [mm]	d ₀ ^{+0.1} [mm]	d1 _{-0.1} ⁰ [mm]	W _{-0.2} ⁰ [mm]	C _{±0.4}	L ₀ ^{+0.3}	(d2×θ)	N [mm]	Load [*] [N] (kgf)	TYPE
231502	TAS-22-H8	22	8	—	7	—	—	—	(17.0)	392 (40)	1
231501	TAS-22-AH1-5	22	—	5	7	1	5	φ3×100°	(11.0)	392 (40)	2

※ネジ軸タイプや他のサイズも制作可能です。
※許容荷重 (毎分 300 回転時)

※Each limiting size can also be supplied.
※Allowable load at 300min⁻¹

1. 圧縮試験 1.Compression examination

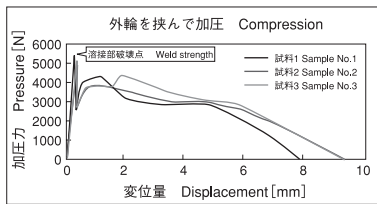
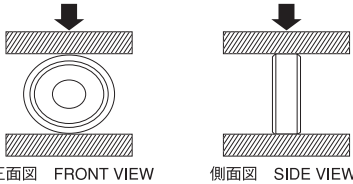

608ZZの強度(約3430N(350Kgf))に対し約1.5倍の圧縮強度
TAS bearing has compression strength about 1.5 times against JIS bearing, 608ZZ, when outer wheel fixed.

2. 圧縮試験 2.Compression examination

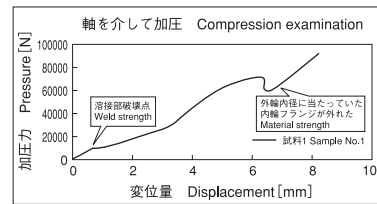
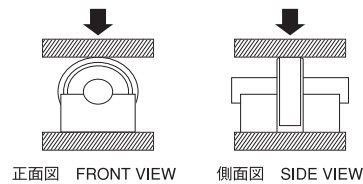

608ZZの強度(5個平均3,556N(368Kgf))に対し約23倍の圧縮強度
TAS bearing has compression strength about 23 times against JIS bearing, 608ZZ, when inside fixed.

3. 起動力試験 3.Motive power examination

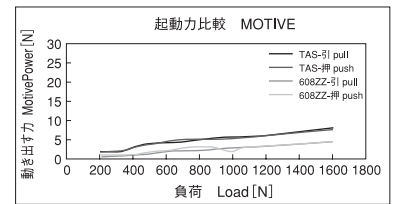
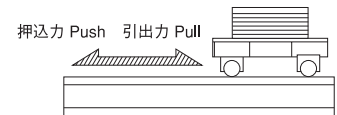

JISベアリング608ZZに対し大差ない起動力を保持します
TAS bearing is equal to JIS bearing, 608ZZ, in motive power.

THF (プレスベアリング) RoHS

寸法 Dimension

THF-612ZZ-4.5

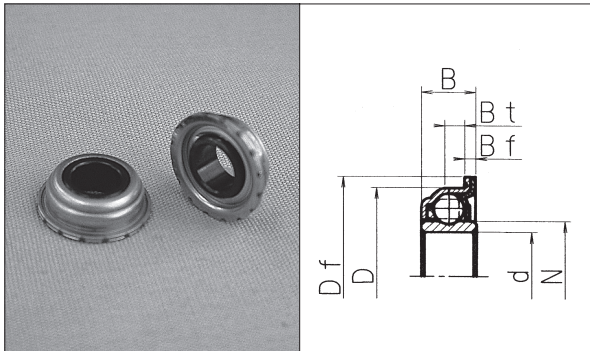

THF-816ZZ-5

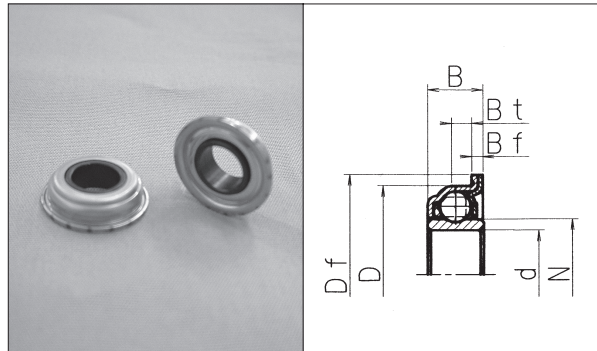

寸法表 Dimension table

Code	Part No.	d ^{+0.03} ₀	D ⁰ _{-0.05}	Df ^{±0.1}	B ⁰ _{-0.1}	Bf	Bt ^{+0.2} ₀	N	Load [*]	備考 Remarks
		[mm]	[mm]	[mm]	[mm]	[mm]	[mm]	[mm]	[N] (kgf)	
760001	THF-612ZZ-4.5	6	12	14	4.5	0.8 ^{±0.1}	1.8	(8.0)	49 (5)	
760002	THF-816ZZ-5	8	16	18	5	1.1 ⁰	1.8	(10.0)	78.4 (8)	JIS規格688ZZ(フランジ型,NR型)のVAタイプ VA model of JIS 688ZZ (Flanged and NR type)

* 許容荷重 (毎分 1500 回 回転時) : 総回転数 1億回転での値です。(弊社耐久試験機による)
 Allowable load at 1500min⁻¹(1500r.p.m) after 100 million rotations by our company's testing equipment

設計仕様 Design specification

1. 取付穴径 (推奨値) Mounting bore diameter (Recommended).
 THF-612ZZ-4.5 φ12^{+0.05}
 THF-816ZZ-5 φ16^{+0.05}
2. 使用板厚 (推奨値) Plate thickness (Recommended) : 1.2mm ≤
3. 使用温度 Operation temperature : 0℃~80℃
4. 保存温度 Storage temperature : -20℃~100℃

耐久データ Endurance Date

試験試料 Test sample	THF-612ZZ-4.5 (インナーレース回転にて軸径はφ5.99を使用) rotation of inner races by the shaft of φ5.99 THF-816ZZ-5 (インナーレース回転にて軸径はφ7.99を使用) rotation of inner races by the shaft of φ7.99
試験条件 (弊社耐久試験機) Test condition (our company's testing equipment)	
ラジアル荷重 Radial load	49.0N (5kgf)/THF612 78.4N (8kgf)/THF816
回転速度 Revolution speed	1500min ⁻¹ (1500r.p.m)
回転モード Revolution mode	6秒回転、1秒停止 (インナーレース回転) (rotation of inner races)
総回転数 Total revolution	10.8 × 10 ⁷ 回転 100 million cycles
環境温度 Temperature	23℃ ± 2℃

ラジアルクリアランス量の変化 Variation of radial clearance

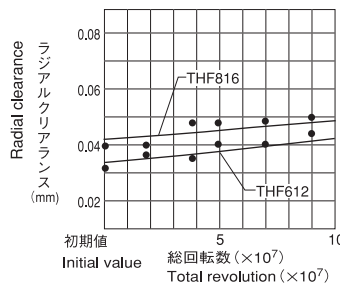

	THF-612ZZ-4.5 Radial clearance [mm]	THF-816ZZ-5 Radial clearance [mm]
初期値 Initial value	0.030	0.040
1.0 × 10 ⁷	0.035	0.040
3.0 × 10 ⁷	0.035	0.050
5.0 × 10 ⁷	0.040	0.050
7.0 × 10 ⁷	0.040	0.050
9.0 × 10 ⁷	0.045	0.050
11.0 × 10 ⁷	0.045	0.050
変化量 Variation value	+0.015	+0.010

アキシャルクリアランス量の変化 Variation of axial clearance

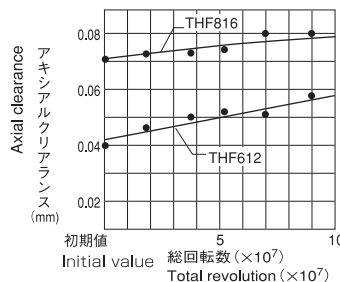

	THF-612ZZ-4.5 Axial clearance [mm]	THF-816ZZ-5 Axial clearance [mm]
初期値 Initial value	0.040	0.070
1.0 × 10 ⁷	0.045	0.070
3.0 × 10 ⁷	0.050	0.070
5.0 × 10 ⁷	0.050	0.070
7.0 × 10 ⁷	0.050	0.080
9.0 × 10 ⁷	0.055	0.080
11.0 × 10 ⁷	0.060	0.080
変化量 Variation value	+0.020	+0.010

SLIDING DOOR WHEELS

トック戸車

RoHS

UNIVERSAL TYPE SLIDING DOOR WHEELS

用途……………引違い書庫、雨戸

特長……………1.構造物への取付を何ら留め具を必要としないで固定できます。
2.構造が簡単で、しかも丈夫で安価です。
3.プラスチック成形品なので、サビません。

耐久性……………49N (5kgf)、ストローク 500mm、10万回の繰返し走行試験後も戸車の回転は円滑です。

Application……………Library, rain-shelter doors.

Features……………1.Clamps are not necessary for fixing on doors.
2.Simple construction, high durability and low cost.
3.All plastic made and free from rust.

Durability……………The door shall be jerked back and forth for 100,000 times in a stroke of 500mm under the 49N (5kgf) load per wheel. After the test, the door should still slide smooth.

Code	Part No.	樹脂製枠材質 Frame material	タイヤ Kind of roller
260001	トック戸車 No.3A TOK DOOR WHEEL No.3 A	Polyethylene (PE)	コロ (PA : ポリアミド) Roller (PA : Polyamide)
260005	トック戸車 No.3B TOK DOOR WHEEL No.3 B	Polyethylene (PE)	ベアリング (DU-30-H6-M) Bearing (DU-30-H6-M)

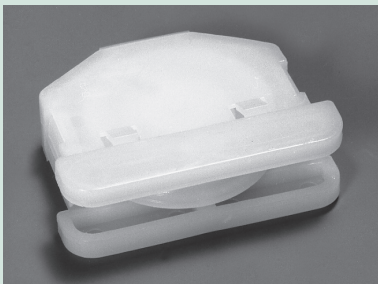

トック戸車No.3A (コロ式)
TOK DOOR WHEEL No.3 A (Roller type)

トック戸車No.3B (ベアリング式)
TOK DOOR WHEEL No.3 B (Bearing type)

取付孔寸法
Sizes of Hole for snap-in fit
L×W×t=40.5×11×1.0 (or 0.8) mm

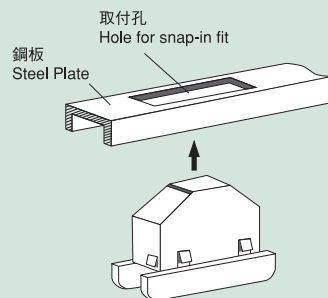

使用方法
Fitting method

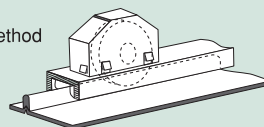

寸法
Dimension

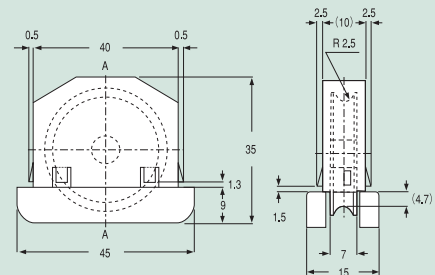

SLIDING DOOR WHEELS

ガラス戸車/ローラーセットスクリーンV **RoHS**

GLASS SLIDING DOOR WHEELS/ROLLER SET SCREEN V

用途…… ショウケース等のガラス戸用戸車
 タイプ…… ガラス戸車(外枠PA) : Dシリーズベアリング(DRS-16-H4.1W0.25)
 タイプ…… ローラーセットスクリーンV : コロ(POM : ポリアセタール製)

Application…… Door Wheels for Glass Door such as of Show-Case
 Type …………… GLASS SLIDING DOOR WHEELS : Bearings (DRS-16-H4.1W0.25)
 Type …………… ROLLER SET SCREEN V : Roller (POM : Polyacetal)

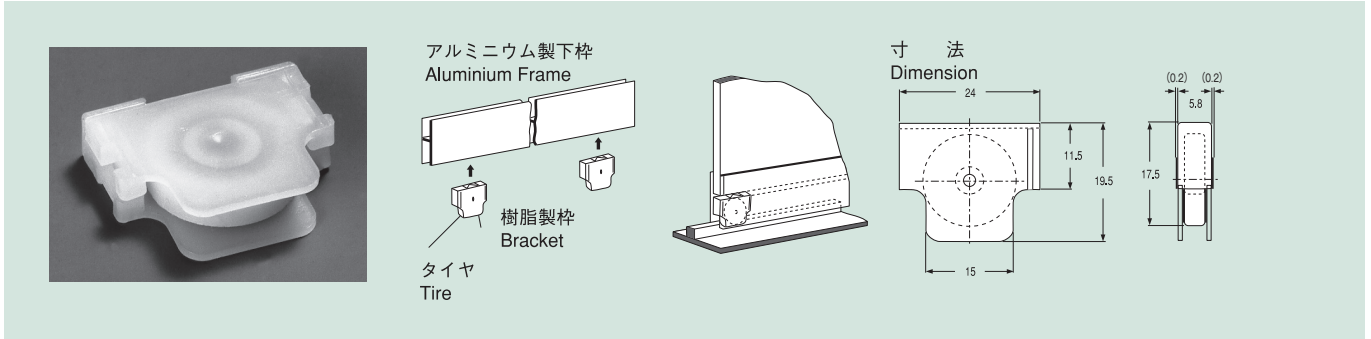

Code	Part No.	樹脂製枠材質 Frame material	タイヤ Kind of roller
260007	ガラス戸車(外枠 PA) GLASS DOOR WHEEL(PA)	Polyamide (PA)	ベアリング (DRS-16-H4.1W0.25) Bearing (DRS-16-H4.1W0.25)
260068	ローラーセットスクリーンV ROLLER SET SCREEN V	Polyamide (PA)	コロ (POM : ポリアセタール) Roller (POM : Polyacetal)

調整式戸車

UNIVERSAL TYPE SLIDING DOOR WHEELS WITH ADJUSTABLE HOUSING

用途…… 雨戸、サッシ戸車
 特長…… 1.取付けの際、何ら留め具なしに固定できます。
 2.プラスチック成形品なのでサビません。
 3.Dシリーズベアリング付で軽快です。

Application…… Wheels for rain-shelter doors, sliding door sashes.
 Features …………… 1.Easy setting without any clamps.
 2.Totally made of plastic moldings and rust free.
 3.Smooth sliding with D-SERIES BEARINGS.

タイプ…… 2種類
 code 260040・アジャスター戸車F型
 code 260042・アジャスター戸車No.7

Variation …………… 2types
 ・ADJUSTABLE DOOR WHEEL F
 ・ADJUSTABLE DOOR WHEEL No.7

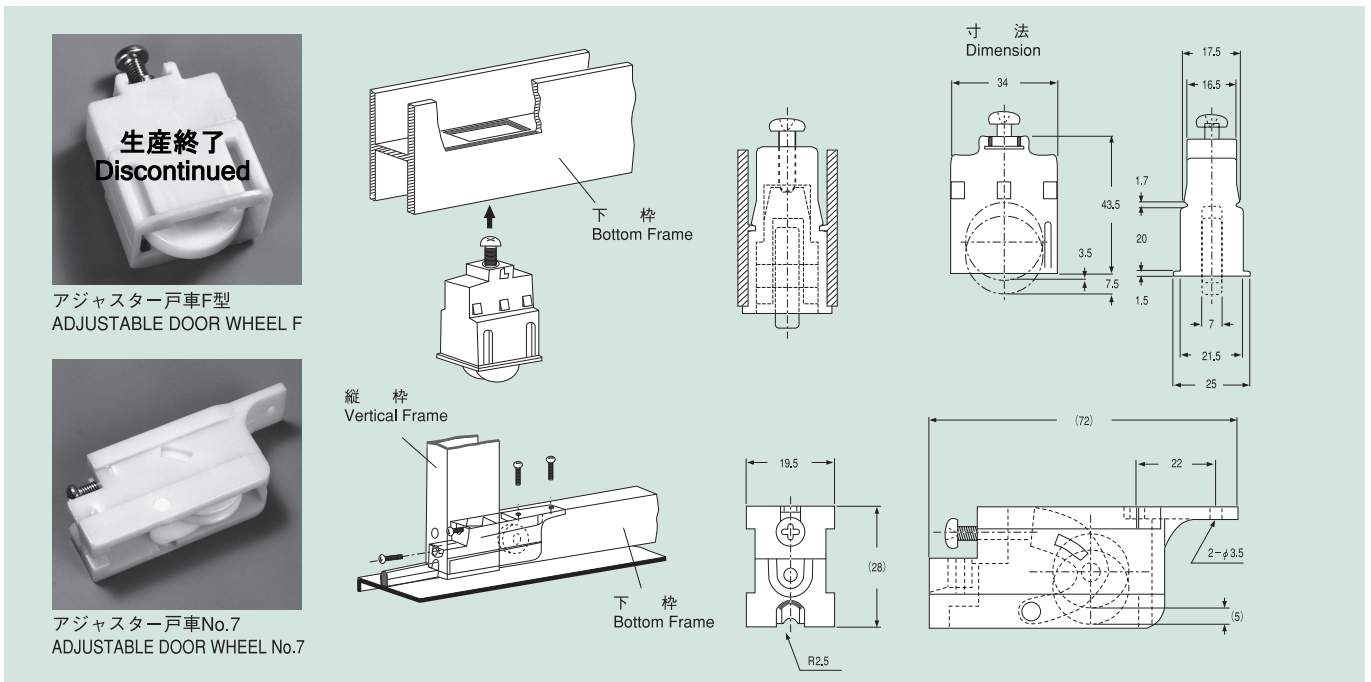

K (特注ベアリング)

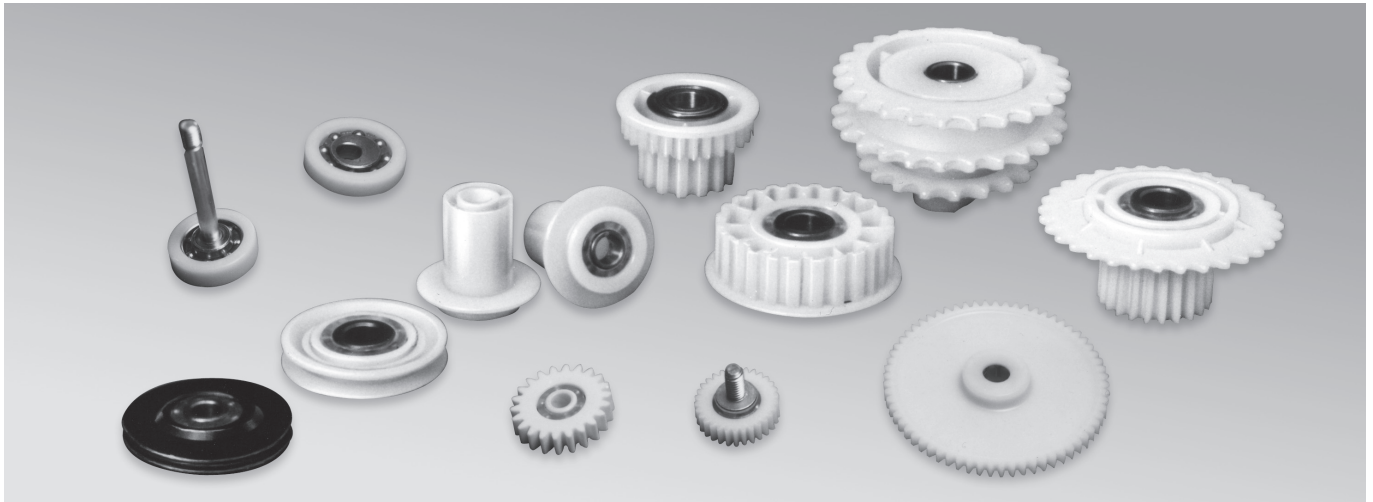

Kシリーズ ベアリングとは

- 1.構成材料はポリアセタール樹脂 (POM) の他、潤滑性、耐摩耗性、軽量化、強度等の要求に応じて最適な材料が選択できます。
- 2.アウターレースに高摺動性プラスチック等を使用し、タイミングギヤ、スプロケットギヤ、その他のギヤ、あるいは、ワイヤー溝付プーリー形状に成形することにより、コストダウンが計れます。
- 3.ユーザー様毎に、ご使用頂くその周辺の状況を総合的に取り入れ、専用に設計された VA 商品を K シリーズベアリングといい、原則としてユーザー様専用金型となります。

THE K-SERIES BEARING

- 1.The K-series bearings can be provided with an optimum material and color besides the acetal resin, and other resin depending on the requirements such as lubricity, wear resistance, and lightweight
- 2.The K-series bearings use lubricious plastic for its outer races, enabling integral molding of timing gears,pulleys etc. are pressfitted along the periphery of the bearings.
- 3.The K-series bearings mean a specially designed VA commodity, which synthetically takes into account its working conditions in each user. Therefore, in principle, the mold is for each exclusive one.

設計基本寸法 Basic sizes

ベアリング穴径 Bore diameter [mm]	設計基本穴径 *1 Basic outside diameter [mm]	設計基本幅 Basic width [mm]
4	16 \leq	4 \leq
5	16 \leq	4 \leq
6	16 \leq	7 \leq
7	18 \leq	7 \leq
8	18.5 \leq	7 \leq
9	24 \leq	7 \leq
10	24 \leq	7 \leq

*1 ギヤの場合は歯底径とする。 Root diameter for gear.

使用例 Applications

- ・ワイヤープーリー
- ・テンションプーリー
- ・スプロケットギヤ
- ・タイミングギヤ
- ・インボリュートギヤ
- ・ Wire pulleys
- ・ Tension pulleys
- ・ Sprocket gears
- ・ Timing gears
- ・ Involute gears

設計上の打ち合わせ事項 Design conditions to be prearranged

- ・ 使用時における最大荷重
- ・ 使用時における最大回転数
- ・ 用途 (ご利用される目的、機構等)
- ・ 周囲環境
- ・ Maximum working load
- ・ Maximum number of revolutions while running
- ・ Applications (objectives, working mechanisms etc.)
- ・ Environment

設計例 Design example

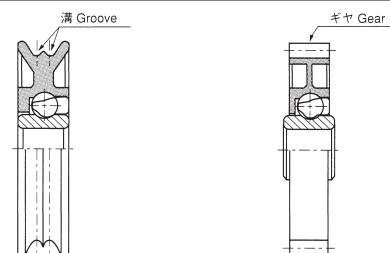

- 2006年 1月 第 1 版
- 2007年 2月 第 2 版
- 2007年 6月 第 3 版
- 2008年 8月 第 4 版
- 2009年 6月 第 5 版
- 2010年10月 第 6 版
- 2012年 6月 第 7 版
- 2013年 6月 第 8 版
- 2017年 4月 第 9 版
- 2017年10月 第10 版
- 2018年11月 第11 版
- 2021年 4月 第12 版
- 2023年 6月 第13 版

■製品の仕様は予告なく変更することがあります。

ご使用にあたっては、「ご使用上の注意」を必ずお読み下さい。

■ Product specifications are subject to change without prior notice.
Before operation, please be sure to read "Caution for Use".

株式会社TOK

東京オフィス Tel:03-3969-1534

大阪オフィス Tel:06-6368-8721

<https://tok-inc.com/>